

iCombi[®] Pro

Operating instructions



Model:
Metos iCombi Pro table unit

4352010, 4352010MK, 4352010MM, 4352010MO, 4352010MR, 4352010N, 4352011, 4352012, 4352012N, 4352013, 4352014, 4352014N, 4352015, 4352018, 4352019, 4352020, 4352020COOP, 4352021, 4352022, 4352022COOP, 4352023, 4352024, 4352025, 4352027, 4352028, 4352030, 4352031, 4352032, 4352036, 4352036MK, 4352036MM, 4352036N, 4352038, 4352039, 4352040, 4352042, 4352042N, 4352044, 4352048, 4352050, 4352050MH, 4352050MK, 4352050MM, 4352050MO, 4352050N, 4352051, 4352052, 4352052MK, 4352053, 4352054, 4352055, 4352056, 4352057, 4352058, 4352058COOP, 4352059, 4352060, 4352060COOP, 4352061, 4352062, 4352063, 4352064, 4352065, 4352066, 4352067, 4352068, 4352068MK, 4352069, 4352070, 4352070MK, 4352070N, 4352071, 4352072, 4352073, 4352074, 4352074N, 4352076, 4352077, 4352080, 4352190

4352010G20, 4352010G30, 4352036G20, 4352036G30, 4352042G20, 4352042G30, 4352048G20, 4352048G30, 4352050G20, 4352050G30, 4352050G30N, 4352070G20, 4352070G30, 4352074G20, 4352074G30, 4352080G20, 4352080G30, 4352128G20, 4352012G20, 4352052G20

Table of contents

1 Introduction	8
1.1 Help displayed on the unit	8
1.2 Product warranty	8
1.3 Target group	8
1.4 Intended use	8
1.5 Working with this manual	8
1.5.1 Explanation of symbols	8
1.5.2 Explanation of pictograms	9
1.5.3 Explanation of safety messages	9
1.5.4 Images	9
1.5.5 Technical changes	9
2 The iCombi Pro	10
3 General safety instructions	11
3.1 Safety instructions for units with a gas connection	12
3.2 Personal protective equipment	13
4 How to work with the unit	14
4.1 Initial start-up	14
4.2 Switching the unit on and off	14
4.3 Start screen	15
4.3.1 Favourite	16
4.3.2 Date, time, status	16
4.4 Interacting with the unit	17
4.4.1 Moves	17
4.4.2 Central dial	17
4.5 Maximum load sizes	17
4.6 Opening and closing the cooking cabinet door	18
4.7 Loading the unit	18
4.7.1 Loading the unit with the mobile oven rack or the mobile plate rack	19
4.7.2 Loading the Combi-Duo with the mobile oven rack or the mobile plate rack	20
4.8 Inserting core temperature probe	22
4.9 Using the hand shower	24
4.10 Removing hinging rack	25
4.11 Integrated fat drain	25
5 Intelligent cooking - iCookingSuite	27
5.1 Operating modes and cooking methods	27
5.2 Intelligent cooking processes	28
5.2.1 Poultry	28
5.2.2 Meat	29
5.2.3 Fish	30
5.2.4 Egg dishes and desserts	31
5.2.5 Vegetables and side dishes	32
5.2.6 Baked goods	34

5.2.7	Finishing	35
5.3	Cooking food intelligently	35
5.3.1	Calling up intelligent cooking process.....	35
5.3.2	Starting intelligent cooking process	36
5.4	Adjusting cooking result to own requirements.....	37
5.4.1	Cooking parameters	37
5.4.2	Additional functions.....	38
5.4.3	Prompts.....	39
5.4.4	Information.....	40
5.4.5	Options.....	40
5.5	Monitor the intelligent cooking path.....	41
5.6	Abort intelligent cooking path.....	41
5.7	Arrange intelligent cooking paths	42
6	Manual cooking.....	43
6.1	Adjusting cooking result to own requirements.....	43
6.1.1	Cooking parameters	43
6.1.2	Additional functions.....	44
6.1.3	Prompts and information.....	44
6.2	Steam	45
6.2.1	Cooking climate and temperature range	45
6.2.2	Cook food in steam.....	45
6.3	Combination of steam and convection heat	46
6.3.1	Cooking climate and temperature range.....	46
6.3.2	Cooking the food in the combination of steam and hot air	46
6.4	Convection	46
6.4.1	Cooking climate and temperature range	46
6.4.2	Cook food in convection heat.....	47
6.5	Abort manual cooking.....	47
7	Sous-vide cooking	49
8	Low temperature cooking.....	50
9	Finishing	51
9.1	Adjust plate weight à la carte.....	51
9.2	Adjust banquet plate weight.....	51
10	iProductionManager.....	52
10.1	Create manual tickets.....	52
10.2	Create shopping carts	53
10.3	Edit ticket board	55
10.4	Place ticket	56
10.4.1	Combination check	57
10.4.2	Placement logic	57
10.4.3	Close planning gaps	57
10.4.4	Time optimisation	58
10.4.5	Energy optimisation	59

10.5	Edit and delete tickets.....	60
10.6	Target time cooking	60
10.7	Planning.....	60
10.7.1	Create planning	61
10.7.2	Start planning.....	62
11	Programming mode	63
11.1	Create manual programme.....	63
11.2	Program intelligent cooking process.....	65
11.3	Programme the shopping cart.....	66
11.4	Edit and delete programmes.....	67
11.5	Start programmes and shopping carts.....	67
12	Switch between operating modes	69
13	Settings.....	70
13.1	Favourites	70
13.2	Display	70
13.2.1	Language.....	70
13.2.2	Date and time.....	70
13.2.3	Temperature format	71
13.2.4	Programme view	71
13.3	Light	71
13.3.1	Display brightness	72
13.4	Sound.....	72
13.4.1	Master volume.....	72
13.4.2	Loading/calls for action	72
13.4.3	Program step end	72
13.4.4	End of cooking time.....	73
13.4.5	Process interruption/error found	73
13.5	cooking system.....	73
13.5.1	Information on unit model.....	73
13.5.2	Demo mode	73
13.5.3	Power Steam.....	73
13.5.4	Control nozzle.....	74
13.5.5	Remote control	74
13.6	Cooking	74
13.6.1	Primary country cuisine.....	74
13.6.2	Secondary country cuisine	74
13.6.3	À la carte plate weight.....	75
13.6.4	Banquet plate weight	75
13.6.5	Number of racks.....	75
13.6.6	Order of racks.....	75
13.6.7	Climate retention time	75
13.6.8	iProductionManager 3D	75
13.7	Cleaning.....	76
13.7.1	Forced cleaning	76

13.7.2	Cleaning plan.....	76
13.8	Data management.....	76
13.8.1	Export HACCP data.....	76
13.8.2	Export and import programmes.....	77
13.8.3	Delete all programs.....	77
13.8.4	Export and import profiles.....	77
13.8.5	Delete all own profiles.....	77
13.8.6	Export and import images.....	77
13.8.7	Delete all own images.....	78
13.8.8	Export and import basic unit settings.....	78
13.8.9	Delete all user data.....	78
13.8.10	Export developer log.....	78
13.8.11	Export error statistics log.....	78
13.9	Network settings.....	78
13.10	User administration.....	79
13.11	Service.....	79
13.11.1	Software update info.....	79
13.11.2	Installed software version.....	79
13.12	ConnectedCooking.....	79
14	Kitchen management.....	80
14.1	Profile and rights management.....	80
14.1.1	Create new profile.....	80
14.1.2	Activate profile.....	81
14.1.3	Transfer profile to other units.....	82
14.1.4	Delete profile.....	82
14.2	Hygiene management.....	82
14.2.1	Logged HACCP data.....	82
14.2.2	Exporting HACCP data.....	83
14.2.3	Transfer HACCP data automatically to ConnectedCooking.....	83
14.3	Connected units to a network.....	83
14.3.1	Establishing a WiFi connection.....	83
14.3.2	Connect network cable.....	84
14.3.3	Establish network connection.....	84
14.4	ConnectedCooking.....	85
14.4.1	Connect unit with ConnectedCooking.....	85
14.5	Perform software update.....	86
15	Automatic cleaning - iCareSystem.....	87
15.1	General safety instructions.....	87
15.2	Cleaning modes.....	88
15.3	Cleaning programmes.....	88
15.4	Cleaning and care status.....	88
15.5	Start automatic clean.....	89
15.6	Abort automatic clean.....	89
15.7	Forced cleaning.....	90

15.8	Cleaning plan	90
16	Care.....	91
16.1	General safety instructions.....	91
16.2	Care intervals.....	91
16.3	Care products	91
16.4	Cleaning cooking cabinet door.....	92
16.5	Descaling the moistening nozzle	93
16.6	Cleaning the air filter	93
16.7	Cleaning the hand shower	94
16.8	Cleaning the control panel.....	94
16.9	Cleaning accessories.....	94
17	Inspiration and help	95
17.1	Search assistant.....	95
17.2	Help displayed on the unit.....	95
17.3	Telephone help.....	95
17.4	Help in a service call.....	95
17.4.1	Automatically transferring service data to ConnectedCooking.....	95
17.4.2	Retrieving service data.....	95
17.5	Problem resolution	96
17.5.1	Error messages heating steam generator	96
17.5.2	Error messages for gas units.....	96
17.5.3	Error messages heating hot air.....	97
17.5.4	Error messages moisture	97
17.5.5	Error messages CleanJet	98
17.5.6	Error messages Care.....	98
17.5.7	Notification centre	98
18	Maintenance	100
18.1	Replacing air filter.....	100
18.2	Replacing the cooking cabinet door gasket.....	101
19	Transport.....	102
19.1	Transport unit.....	102
20	Decommissioning and disposal	104
20.1	Decommissioning	104
20.2	Disposal.....	104
21	Technical data.....	105
21.1	Units with an electrical connection	105
21.2	Units with a gas connection	105
21.3	Models and version names.....	105
21.4	Conformity.....	105
21.4.1	Units with an electrical connection	105
21.4.2	Units with a gas connection	106
22	Regulatory Information	107
	Index.....	108

1 Introduction

Dear customer,

Congratulations on purchasing your new iCombi Pro. Read the operating instructions carefully prior to using your unit for the first time. The operating instructions are there to ensure that you use the unit safely. Keep these operating instructions in a place that is accessible at all times to anyone who will be using the unit.

The iCombi Pro is the most intelligent combi-steamer. It cooks a multitude of different dishes for 20 or several thousands of guests. Whether these are fish, meat, poultry, side dishes or baked goods, or whether they are fried, steamed, grilled or baked. Thanks to its cooking intelligence and its intelligent climate management, this is all done automatically, to the point, even with a maximum load.

We hope you enjoy using your iCombi Pro.

Yours

RATIONAL UK Limited

1.1 Help displayed on the unit

These operating instructions and a large number of application examples from around the world are available in the unit for operational assistance. You can find all the information on this function here: Help displayed on the unit [▶ 95]

1.2 Product warranty

Register your unit now at www.rational-online.com/warranty and benefit from the 2-year warranty. You will also find the general warranty conditions and warranty services on this page.

RATIONAL assumes no liability for damage caused by unauthorised technical changes.

1.3 Target group

This document is intended for staff working in large and commercial kitchens.

The unit may not be used, cleaned, or maintained by the following groups of persons:

- Persons with reduced physical, sensory or mental capabilities
- Persons lacking experience and knowledge
- Children

Supervise children standing near the unit. Children may not play with the unit.

1.4 Intended use

The iCombi Pro has been developed for the preparation of hot food.

This unit may only be used commercially, such as in restaurant kitchens and large and commercial kitchens in hospitals, bakeries or butcheries. This unit may not be used outdoors. This unit may not be used for continuous industrial mass production of food.

All other uses are contrary to the intended purpose, and may be dangerous. RATIONAL AG assumes no liability for the consequences of using the unit contrary to the intended use.

1.5 Working with this manual

1.5.1 Explanation of symbols

The following symbols are used in this document to inform and guide you:

- ✓ This symbol marks conditions which must be met prior to performing an action.
 1. This symbol marks an action step you must perform.
 - > This symbol marks an interim result that you can use to assess the result of an action step.
 - >> This symbol marks a result that you can use to assess the end result of an action instruction.
 - This symbol marks a bulleted list.

- a. This symbol marks a list.

1.5.2 Explanation of pictograms

The following pictograms are used in this document:

 Caution! Read the operating instructions before using the unit.

 General warning symbol

 Useful tips for simple use of your unit.

1.5.3 Explanation of safety messages

If you see the following safety messages, you are being warned about hazardous situations and instructed to avoid these situations.

DANGER

If you see the signal word DANGER, you are being warned about situations that lead to serious injury or death.

WARNING

If you see the signal word WARNING, you are being warned about situations that may lead to serious injury or death.

CAUTION

If you see the signal word CAUTION, you are being warned about situations that may lead to injury.

NOTICE

If you see this notice, you are being warned about situations that may cause damage to the unit.

1.5.4 Images

The images used in these operating instructions may differ from the actual unit.

1.5.5 Technical changes

We reserve the right to make technical changes in the interest of progress.

2 The iCombi Pro

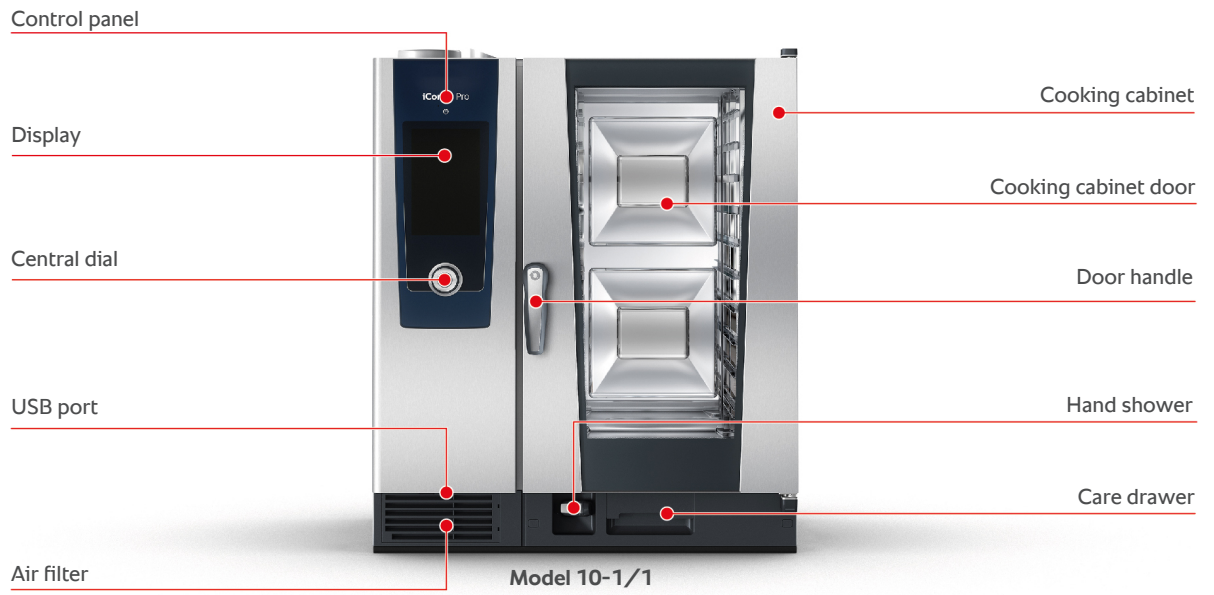

3 General safety instructions

The unit is designed to be safe and will not present any danger if used in a correct and proper way. These instructions describe how to use the unit correctly.

- Your unit must be installed by your RATIONAL Service Partner or qualified installer.
- Your unit must be maintained by your RATIONAL Service Partner.
- Do not modify the unit or the unit installation undertaken by your RATIONAL Service Partner.
- Do not use the unit if it is damaged. A damaged unit is not safe and can cause damage or fire.
- Do not use the unit if a glass panel on the cooking cabinet door is damaged. Contact your RATIONAL Service Partner and have them replace the glass panel on the cooking cabinet door.
- Do not place any objects on the unit.
- Do not store any flammable or combustible substances near the unit.
- Only use the unit at an ambient temperature of +10 °C to +40 °C.
- Avoid having heat sources, e.g. grill plates or deep-fat fryers, near the unit.
- During operation, ensure that the floor surrounding the unit is dry and non-slip.

Safety instructions before use

- Make sure the unit is at a temperature of at least + 5°C.
- Make sure that the air baffle in front of the fan wheel is locked at the top and bottom.
- Make sure that the hinging rack or the mobile oven rack are locked.
- Make sure that there are no residues from cleaner tablets in the cooking cabinet.
- If the unit is used again after a long period of downtime, rinse the hand shower through with at least 10 litres of water.

Safety instructions during use

- This will prevent scalding and burns:
 - Open the cooking cabinet door carefully during use. Hot steam may escape.
 - Wear personal protective equipment if you are removing accessories or objects from the hot cooking cabinet.
 - Only touch the unit on the control panel and the cooking cabinet door when in operation. The outer surfaces can reach temperatures of over 60°C.
 - Only slide containers with food into racks you can see into. Hot food can otherwise spill out when removing them from the unit.
- This will prevent fire and explosion hazards:

- Do not cook with highly flammable liquids such as alcoholic drinks in the unit. Highly flammable liquids can self-ignite when cooking. Before cooking food in highly flammable liquids, boil down the liquid for a longer time to reduce the alcohol content.
- With grilling and roasting applications, use a fat collector under the food.
- This will prevent injuries when working with transport trolleys, mobile oven racks or mobile plate racks:
 - Carefully push transport trolleys, mobile oven racks or mobile plate racks over thresholds and uneven floors to prevent them from tilting.
 - Apply the brakes on transport trolleys, mobile oven racks or mobile plate racks to prevent them from rolling away on uneven floors.
 - Secure the transport trolley to your unit before sliding a mobile oven rack or mobile plate rack into the unit or removing them from the unit.
 - Apply the container lock on the mobile oven rack and cover containers holding hot food when moving mobile oven racks. Hot food can otherwise spill out.
- To prevent material damage due to improper use of accessories:
 - Use only original RATIONAL accessories.
 - Use only the VarioSmoker to smoke food.
- Cold food is not to be added to the unit for rethermalization while hot food is being held.

Safety instructions after use

- Clean the unit after every use.
- To prevent corrosion in the cooking cabinet, leave the cabinet door slightly open if it is going to be idle for a prolonged period and overnight.
- For long stoppages, shut off the water, power and gas supplies to the unit.
- For long stoppages and prior to transportation of the unit, empty the steam generator.

3.1 Safety instructions for units with a gas connection

- This will prevent fire hazards:
 - If your unit is connected to a chimney, contact your gas installer regularly to clean the ventilation pipe of the unit. Ensure that the provisions specific to the country are complied with.
 - Do not put objects on the exhaust pipes.
- This will prevent fatal accidents:
 - If your unit is operated with a exhaust hood, always switch on the exhaust hood during operation. Combustion gases may otherwise accumulate.
- If you smell gas, proceed as follows:

- Do not press any light or unit switches, do not pull any plugs from sockets and do not use mobile telephones or phones. This may cause sparks and increase the risk of an explosion.
- Open the windows and doors and ventilate the room with fresh air. Do not switch on any exhaust hoods or ventilators to ventilate the room. This may cause sparks and increase the risk of an explosion.
- Close the shut-off valve on the gas line.
- Leave the building and contact your gas supplier or the fire services.

3.2 Personal protective equipment

- When working with the unit, only wear clothing that cannot cause a work accident, particularly due to heat, splashing hot liquids or corrosive substances.
- Wear protective gloves for reliable protection when handling hot objects and sharp-edged trays.
- Wear tight-fitting protective glasses and chemical-safe protective gloves when cleaning to ensure reliable protection when handling care products.

4 How to work with the unit

4.1 Initial start-up

When starting up your unit for the first time, it has already been properly installed by a RATIONAL Service Partner. The self-test has already been performed and the unit is therefore ready for operation. You can find all the information on installation in the installation manual enclosed.

Before working with the unit for the first time

1. Clean the unit and accessories before using the unit for the first time.

Click here for more information: Care [► 91]

4.2 Switching the unit on and off

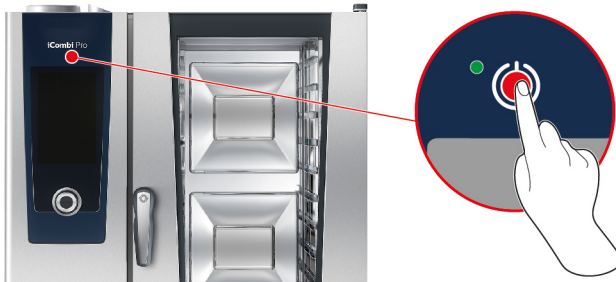

1. To switch on the unit, press and hold the button until the LED lights green: (⏻)
 - > The unit will start. The start screen [► 15] will appear.
2. To switch off the unit, press and hold the button: (⏻)
 - > You will be asked whether you really want to switch off the unit.
3. Press the button **OK**
 - >> The unit will be switched off.

4.3 Start screen

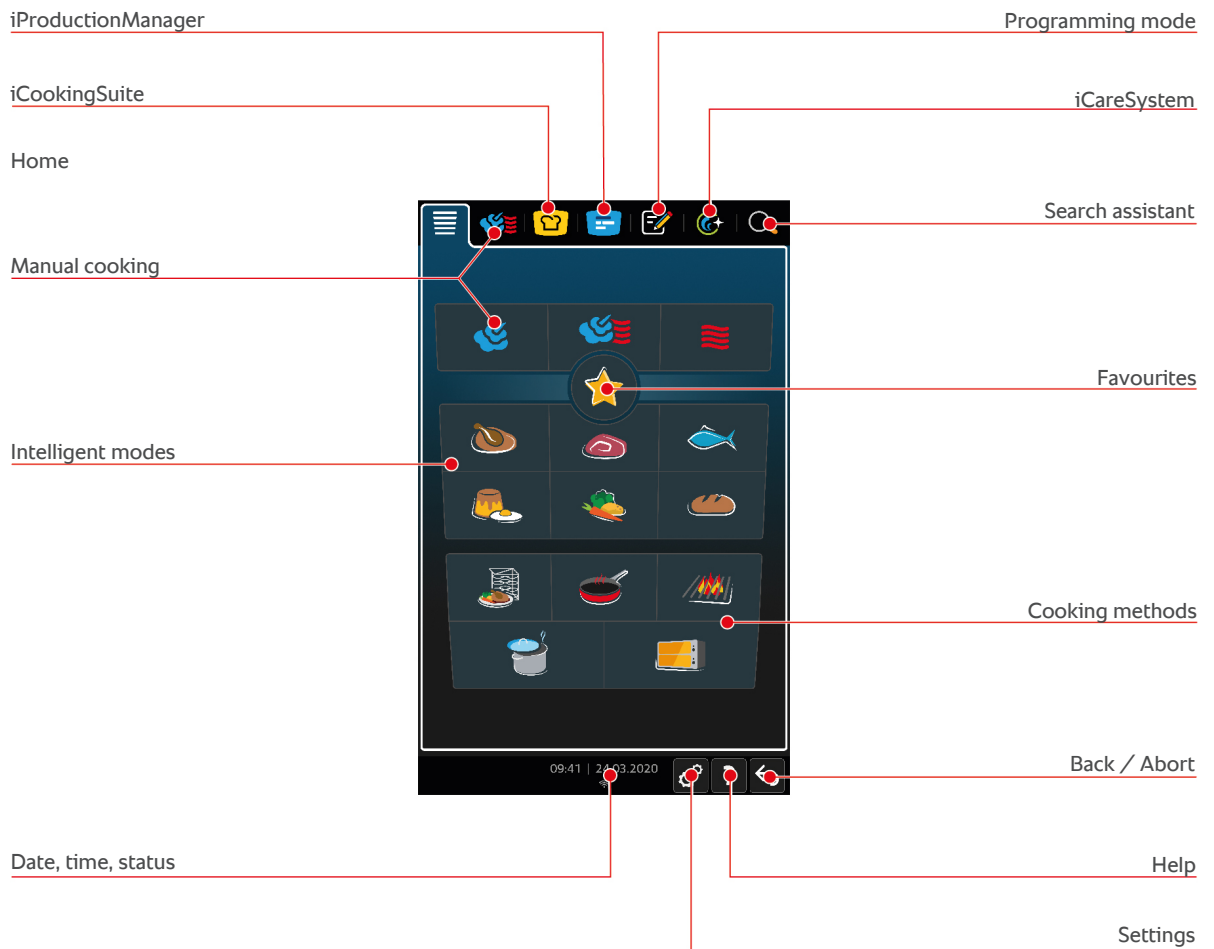

- [iProductionManager \[▶ 52\]](#)
- [Intelligent cooking - iCookingSuite \[▶ 27\]](#)
- [Home](#)

If you press this button, you will be navigated to the start screen. You can customise the start screen as you wish.
- [Manual operating modes \[▶ 43\]](#)
- [Favourite \[▶ 16\]](#)
- [Intelligent modes \[▶ 27\]](#)

If you press one of these buttons, all intelligent cooking processes categorised as intelligent modes will be displayed.
- [Cooking methods](#)



If you press this button, all intelligent cooking paths attributed to this mode will be displayed.
- [Programming mode \[▶ 63\]](#)
- [Search assistant \[▶ 95\]](#)
- [Automatic cleaning - iCareSystem \[▶ 87\]](#)
- [Date, time, status \[▶ 16\]](#)
- [Settings \[▶ 70\]](#)
- [Help displayed on the unit \[▶ 95\]](#)
- [Back / Abort](#)

If you press this button, you will return to the previous screen. If you press and hold this button, you will abort a cooking process.

4.3.1 Favourite

You can save intelligent cooking paths and programs you use often as favourites and call them up from the home screen. This can give you fast access to the dishes on a seasonal menu, for example.



1. In the iCookingSuite or in the programming mode, select the cooking paths or programs you would like to save as favourites.
 2. Press the button 
 3. Press the button 
- >> All cooking paths and programs saved as favourites are displayed.

4.3.2 Date, time, status

In the footer, you can see the current date and time at all times, as well as the status of the following ports and connections:



USB flash drive connected

This symbol shows that you have connected a USB flash drive to the unit.



Network connection

This symbol shows that your unit is connected to a LAN network. If there is a network error, the following symbol will be displayed: 



WLAN connection

This symbol shows that your unit is connected to the WLAN network. The connection quality is very good.

If the connection quality decreases, the following symbols are displayed: 

If there is a connection error, the following symbol is displayed: 



Error report

This symbol shows that an error message is displayed on the display.



ConnectedCooking connection

This symbol shows that your unit is connected to ConnectedCooking. If your unit is not connected to ConnectedCooking, the following symbol will be displayed: 



Water connection

This symbol shows that your unit is not connected to the water inlet.

4.4 Interacting with the unit

NOTICE

Incorrect operation of the display

The display could be damaged if you operate it with a sharp object.

1. Only operate the unit with your fingers.

4.4.1 Moves

You can operate your unit with a few simple moves.



Press

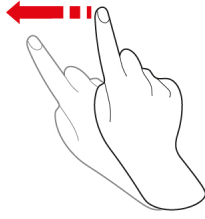

Swipe

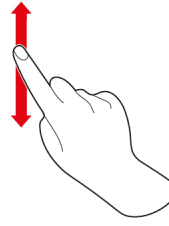

Scroll

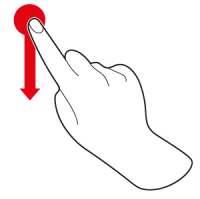

Drag-and-drop

4.4.2 Central dial



Instead of the Moves [► 17], you can modify settings by turning the central dial. Confirm actions by pressing the central dial.

4.5 Maximum load sizes

NOTICE

High load sizes could damage the unit

If you exceed the maximum load size, this may damage the unit.

1. Only load the unit with the maximum load sizes stated here

Model	Max. load size [kg]	Max. load per level
6-1/1	30 kg	15 kg
6-2/1	60 kg	30 kg
10-1/1	45 kg	15 kg
10-2/1	90 kg	30 kg

4.6 Opening and closing the cooking cabinet door



Opening cooking cabinet door

1. Turn the cooking cabinet door handle to the right.
 2. If your unit is equipped with a safety door lock, turn the cooking cabinet door to the left first and then to the right.
 3. Open the cooking cabinet door slowly. **⚠ CAUTION! Scalding hazard! If the unit is in operation, hot steam may surge out of the cooking cabinet.**
- >> The fan wheel is slowed down.

Closing the cooking cabinet door

1. Press the cooking cabinet door firmly.

4.7 Loading the unit

1. Open the cabinet door.
 - > The brakes on the fan wheel will be activated and will brake the fan wheel.
2. Push the food into the unit.
3. If you are grilling or frying the food, push a container under the food to collect the fat.
4. Close the cooking cabinet door. Make sure that the cooking cabinet door is fully closed and the cooking cabinet door handle is in the vertical position.

Rack level over 1.60 m

If your unit has been installed so that the top rack is 1.60 m above the floor, you must apply the warning symbol supplied at that position.

4.7.1 Loading the unit with the mobile oven rack or the mobile plate rack

WARNING

If you are transporting mobile oven racks that are loaded with containers that contain hot food and that are not covered, hot food can spill over

You may scald yourself if you touch hot food.

1. Cover containers filled with hot liquids or hot food during transport in mobile oven racks.

CAUTION

Transport trolleys and mobile oven racks can move when being loaded or unloaded

If you do not apply the parking brakes before loading or unloading the transport trolley or mobile oven rack, the trolleys could move and injure you.

1. Apply the parking brakes on the castors before loading or unloading the transport trolley or mobile oven rack.



1. Remove the hinging rack [► 25].
2. Place the run-in rail for the mobile oven rack on the floor of the cooking chamber, so that the 2 fixing pins are inserted in the recesses intended for them in the rear part of the cooking chamber.
3. Press firmly on the front part of the run-in rail so that the run-in rail is fixed in the cooking cabinet.
4. Move the transport trolley as far as it will go on the unit (A).
5. Press the lever on the transport trolley (B).
 - > The transport trolley is now locked on the run-in rail.
6. Apply the parking brakes of the transport trolley (C).
7. Now push the mobile oven rack or the mobile plate rack into the cooking cabinet as far as it will go in the run-in rail.
8. Press the lever (D).
 - > The transport trolley lock is released.
9. Release the locking brakes on the transport trolley.
10. Take the transport trolley away from the unit to its storage location.
11. Close the cooking cabinet door. Make sure that the cooking cabinet door is fully closed.

4.7.2 Loading the Combi-Duo with the mobile oven rack or the mobile plate rack

WARNING

If you are transporting mobile oven racks that are loaded with containers that contain hot food and that are not covered, hot food can spill over

You may scald yourself if you touch hot food.

1. Cover containers filled with hot liquids or hot food during transport in mobile oven racks.

CAUTION

Transport trolleys and mobile oven racks can move when being loaded or unloaded

If you do not apply the parking brakes before loading or unloading the transport trolley or mobile oven rack, the trolleys could move and injure you.

1. Apply the parking brakes on the castors before loading or unloading the transport trolley or mobile oven rack.



1. Remove the hinging rack. [▶ 25]
2. Place the run-in rail for the mobile oven rack on the floor of the cooking cabinet so that the 2 fixing pins are inserted in the recesses intended for them in the rear part of the cooking cabinet.
3. Press firmly on the front part of the run-in rail so that the run-in rail is fixed in the cooking cabinet.
4. Move the transport trolley as far as it will go on the unit.
5. To load the top unit of the Combi-Duo, press the lever on the transport trolley and pull the handle towards you (A).
 - > The transport trolley is now locked on the run-in rail.
6. Now push the mobile oven rack or the mobile plate rack into the cooking cabinet as far as it will go in the run-in rail.
7. Pull the lever on the right side of the mobile oven rack or mobile plate rack towards you and apply the brakes. This ensures that the mobile oven rack or mobile plate rack remains securely in the cooking cabinet.
8. Apply the parking brakes of the transport trolley.
9. Press the lever on the transport trolley back to its original position.
 - > The transport trolley lock is released.
10. To load the bottom unit of the Combi-Duo, press the lever on the transport trolley forwards and then pull the handle upwards (B).
 - > The transport trolley is now locked on the run-in rail.
11. Now push the mobile oven rack or the mobile plate rack into the cooking cabinet as far as it will go in the run-in rail.
12. Pull the lever on the right side of the mobile oven rack or mobile plate rack towards you and apply the brakes. This ensures that the mobile oven rack or mobile plate rack remains securely in the cooking cabinet.
13. Press the lever on the transport trolley back to its original position.
 - > The transport trolley lock is released.
14. Take the transport trolley away from the unit to its storage location.
15. Close the cooking cabinet doors. Make sure that the cooking cabinet doors are fully closed.

4.8 Inserting core temperature probe

The following sections describe how to work both with the core probe and with the optional 2 externally attachable core probes. Together with the core probe in the cooking cabinet, this gives you 3 core probes in total. This is recommended particularly if you are cooking food with the iProductionManager.

⚠ CAUTION

Hot core probe

There is a risk of burns if you touch the hot core probe without protective gloves.

1. Always wear protective gloves when working with the hot core probe.
2. If necessary, cool down the core probe using the hand shower.

⚠ CAUTION

Sharp core probe

You could injure yourself with the tip of the core probe if you do not work carefully with it.

1. Always wear protective gloves when working with the hot core probe.
2. After use, insert the core probe into the holder provided.

NOTICE

The core probe is hanging out the cooking cabinet

If you do not insert the core probe into the holder provided after use, the core probe may be damaged.

1. After use, insert the core probe into the holder provided.



TIP

- If you regularly cook very thin or liquid food, it is recommend to use the optional positioning aid. First insert the core probe in the positioning aid and then into the food.
- If the core probe is warmer than the set core temperature, cool down the core probe using the hand shower.

Meat, e.g. steak

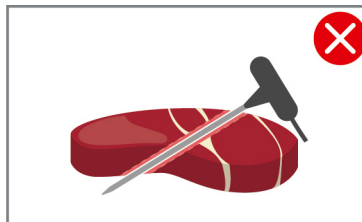
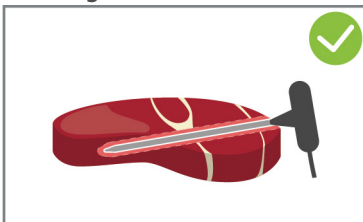

1. Insert the core probe up to the handle into the food at an angle so that the core probe is as far into the food as possible.

Large pieces of meat, e.g. roasts

1. Insert the core probe up to the handle into the thickest point of the food.

Small food item, e.g. goulash

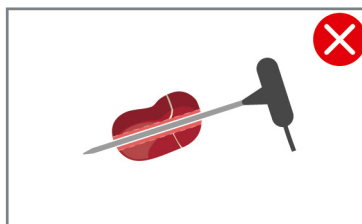
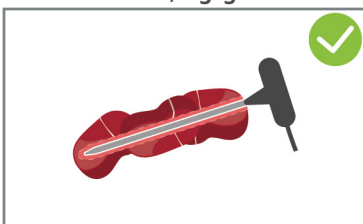

1. Insert the core probe into as many pieces of food until the core probe is full with food from the tip to the handle.

Food of different sizes

1. First insert the core probe into the smallest piece of the food.
2. Once the desired core temperature has been reached, remove the small pieces of food from the core probe and from the cooking cabinet.
3. Then insert the core probe into a larger piece of the food and continue the cooking process with the **Move**  option.

Fish fillets

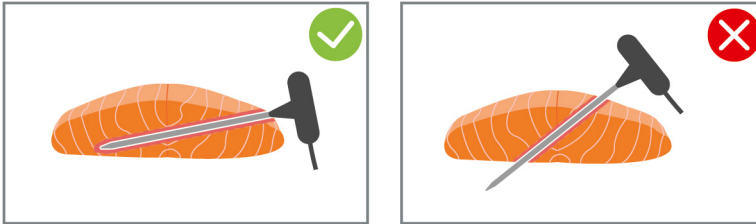

1. Insert the core probe up to the handle into the food at an angle so that the core probe is as far into the food as possible.

Whole fish

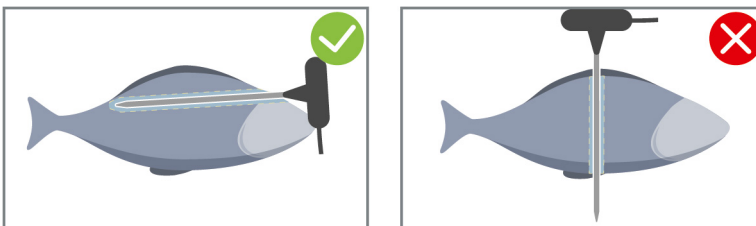

1. Insert the core probe up to the handle into the thickest point of the food. Make sure that the tip of the core probe does not protrude into the abdominal cavity of the fish.

Vegetables, e.g. potatoes

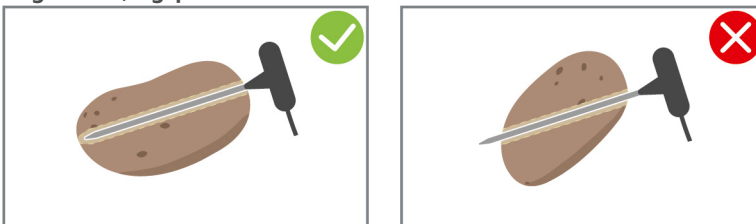

1. Insert the core probe up to the handle into the thickest point of the food.

Soups, sauces, desserts

1. Place the core probe in the Gastronorm container so that the core probe is completely covered with liquid.
2. If you stir the liquid, leave the core probe in the Gastronorm container.

Baked goods

1. For baked goods that rise during baking, place the core probe vertically in the middle of the product. To do this, use the optional positioning aid.

Finishing with mobile plate rack

1. Insert the core probe in the white ceramic tube of the mobile plate rack.

Core temperature probe not recognised

- ✓ The symbol will be displayed:

1. Place the core probe as described in the manual into the product.
 2. Confirm the correction.
- >> The cooking process is not performed correctly. If you do not confirm the correction, the cooking process will be aborted and you will have to start again. Some cooking processes, such as **Overnight boiling**, will continue despite the error.

Remove core probe

1. Once the food has reached the desired core temperature, first remove the core probe from the food and then the food from the cooking cabinet.
2. Insert the core probe into the holder provided.

4.9 Using the hand shower

The hand shower has two adjustable spray patterns, spray  (A) and jet  (B).

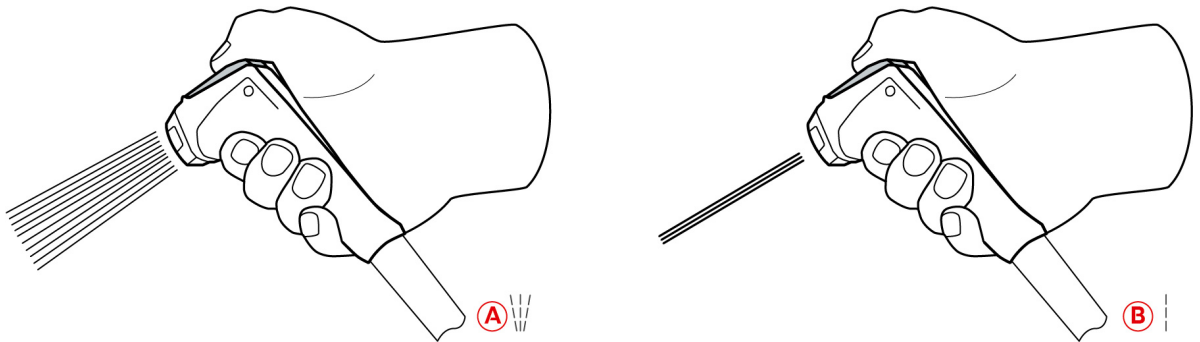

CAUTION

The hand shower and the water coming out of the hand shower can reach over 60 °C

You could burn yourself if you touch hot components or come in contact with hot water.

1. Wear protective gloves while working with the hand shower.

CAUTION

Germ formation in the water pipe

If you do not use the hand shower daily, germs may form in the water line.

1. Rinse the hand shower through with water in the morning and in the evening for 10 seconds.

NOTICE

Improper handling of the hand shower

If you pull the hand shower out beyond the maximum hose length or rip the hose, the automatic retraction system of the hand shower may be damaged. Then hand shower will no longer automatically retract into the housing.

1. Do not pull the hand shower beyond the maximum hose length.



NOTICE

The hand shower is not suitable for cooling down the cooking cabinet

If you cool down the cooking cabinet with the hand shower, this could damage the cooking cabinet, air baffle or the glass panels of the cooking cabinet door.

1. Only cool down the cooking cabinet using the cool down function.

1. Pull the hand shower at least 20 cm out of the park position.

2. Hold the hand shower hose firmly.
3. Turn the front part of the hand shower to select the desired spray pattern.
 - Set the hand shower to  to select the **jet** spray pattern.
 - Set the hand shower to  to select the **spray** pattern.

If you do not turn the front part of the hand shower to one of the two spray patterns, water can drip from the shower head.

1. Press the lever on the hand shower. The harder you press the lever, the stronger the water stream will be.
2. After use, let the hand shower slowly retract into the housing. **⚠ CAUTION! Make sure that the hose of the hand shower is clean before letting it retract into the housing.**

4.10 Removing hinging rack

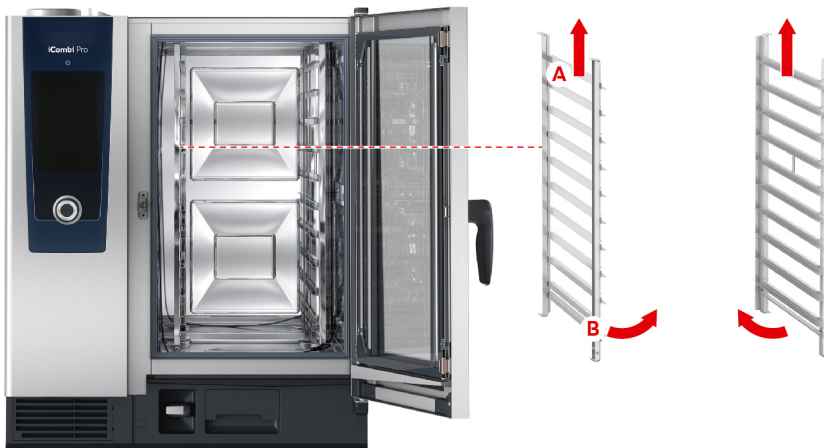

1. Hold the hinging rack in the middle of the top trays.
2. Press the hinging rack upwards (A).
3. Tilt the left hinging rack in the cooking cabinet (B).
4. Take the hinging rack off the hinges and remove it from the cooking cabinet.

4.11 Integrated fat drain

If your unit is equipped with the optional integrated fat drain, dripping fat is collected in the cooking chamber and directed into the fat collecting container.



1	Ball valve handle	2	Drain pipe
3	Filler pipe with bayonet fastener	4	Grease drip collector

1. Open the cabinet door.
 2. Remove the drain pipe fastener.
 3. Place the fat collecting tray in the cooking chamber, so that the opening of the fat collecting tray is on the drain pipe.
 4. Place a fat container under the drain on the outside of the unit, e.g. a canister.
 5. Insert the filler pipe of the integrated fat drain into the fat collecting container.
 6. Insert the bayonet fastener of the filler pipe onto the drain.
 7. Lock the bayonet fastener.
 8. Turn the handle of the ball valve to a horizontal position.
- >> The ball valve is open. Dripping fat can now be collected in the fat collecting container.

Replace the fat collecting container

⚠ CAUTION

The outside of the unit, the drain and the fat collecting container can get very hot
 You can burn yourself if you come into contact with hot functional parts.

1. Wear your personal protective equipment when changing the fat collecting container.

1. When the fat collecting container is full, turn the handle of the ball valve to the vertical position.
 > The ball valve is closed.
2. Loosen the bayonet fastener.
3. Replace the fat collecting container.
4. Dispose of the fat properly. **NOTICE! Fat and other liquid substances that are collected in the fat collecting container must be disposed of in compliance with legal requirements. Never dispose of fat in the drain. Never use fat that you have collected in the fat collecting container to cook food or as food.**

5 Intelligent cooking - iCookingSuite



The iCookingSuite is the cooking intelligence in the iCombi Pro. You select which food is to be cooked with which cooking method. With this selection, a wide range of cooking processes will be offered so you can achieve the ideal cooking result. If required, you can adjust the cooking result using cooking parameters to your requirements, such as by intensifying the browning or changing the cooking level from rare to well done.

While the cooking process is running, all the important cooking parameters such as the cooking cabinet temperature, climate, air speed and cooking time will be regularly adjusted, so that your desired result is achieved. If required, you can intervene in the cooking process even during cooking and change the cooking result. For you this means it is easy to use, no checking, no monitoring. This means you gain time, save raw materials and energy and always have outstanding standardised food quality.





5.1 Operating modes and cooking methods

The following modes are available:

- Poultry 🍗
- Meat 🥩
- Fish 🐟
- Egg dishes and desserts 🥞
- Vegetables and side dishes 🥦

The following cooking methods are available:

- Cooking 🍲
- Frying 🍳
- Baking 🍞

- Grilling 
- Finishing 

A specific set of intelligent cooking paths is assigned to each operating mode. These cooking paths reflect cultural cooking habits that you can set in the primary national cuisine [▶ 74] and the secondary national cuisine [▶ 74].

5.2 Intelligent cooking processes

5.2.1 Poultry

Cantonese Duck

Select this cooking path if you would like to prepare Cantonese duck.

Duck

Select this cooking path if you would like to prepare whole ducks, duck breast or duck legs.

Steam

Select this cooking path if you want to steam poultry.

Deep-fry

Select this cooking path if you would like to deep-fry poultry pieces.

Goose

Select this cooking path if you would like to prepare a whole goose, goose breast or leg of goose.

Grill

Select this cooking path if you would like to grill poultry parts, like chicken breast, turkey steaks or chicken wings.

Chicken

Select this cooking path if you would like to prepare whole chickens, poussins or larger pieces of poultry.

- If you would like to prepare small pieces of poultry, select the cooking path Pan-fry.
- If you need short post-production times for grilled chickens, select the cooking path Overcrust.

Boiling

Select this cooking path if you would like to cook poultry dishes, e.g. chicken soup or terrines.

Pan-fry

Select this cooking path if you would like to prepare smaller poultry parts, like turkeys or chicken wings, or Barbarie duck breast.

Roast at low temperature

Select this cooking path if you would like to roast poultry at a low temperature. Also select this cooking path if you would like to roast poultry with crispy skin overnight or if you are not in the kitchen.

In order to ensure the best quality and juiciness of the food to be cooked, even during longer phases when the food is in the cooking cabinet with the **Maintain** option, the cooking cabinet temperature is reduced when the desired core temperature has been reached. This reduced cooking chamber temperature also ensures that hygienically clean food is produced.

Breaded items

Select this cooking path if you would like to prepare breaded poultry.

Peking duck

Select this cooking path if you would like to prepare traditional Peking duck.

Turkey

Select this cooking path if you would like to prepare whole turkeys or parts of the turkey. Also select this cooking path if you would like to prepare stuffed turkeys.

Braise

Select this cooking path if you would like to braise poultry.

Tandoori

Select this cooking path if you would like to prepare poultry that has been marinated in tandoori paste and is to be cooked in the ideal climate.

Tsukeyaki

Select this cooking path if you would like to prepare poultry that has been marinated in Tsukeyaki sauce and is to be cooked in the ideal climate.

5.2.2 Meat**Bacon**

Select this cooking process if you would like to prepare bacon.

Roasting with crust

Select this cooking process if you want to cook large pieces of meat with crackling.

Braised pork

Select this cooking path if you would like to braise pork Chinese style in soya sauce.

Broth/boil

Select this cooking path if you would like to prepare boiled or cooked sausages in artificial or natural casings.

Char Siu

Select this cooking path if you would like to prepare Chinese Char Siu.

Cochinita pibil

Select this cooking path if you would like to prepare Mexican Cochinita Pibil or another dish that braises in its own juice. The cooking chamber climate is optimised for these stew dishes.

Crispy pork belly

Select this cooking path if you would like to prepare Chinese crispy pork belly.

Meat in pastry

Select this cooking path if you would like to prepare meat in pastry or in salt crust.

Deep-fry

Select this cooking process if you want to deep-fry meat pieces.

Large roasts

Select this cooking process if you want to fry large pieces of meat.

Grill

Select this cooking path if you want to cook pieces of meat with a grill pattern.

Semi-preserves

Select this cooking path if you are using meat, for example if you would like to make boiled and cooked sausages, ragout or goulash semi-preserves. To make semi-preserves safely, you need a reference container with a lid.

1. Make a hole in the lid of the reference container. Do not use the core temperature probe to do this.

2. Put the food into the desired containers and close them with their lids.
3. Start the cooking paths and load the unit.
4. Insert the core temperature probe through the hole in the lid of the reference container.

The cooking path **semi-preserves** regulates to an F-value of 0.3. The semi-preserves produced in this way have a shelf life of up to 6 months at a storage temperature of less than 10 °C.

Kebab

Select this cooking process if you would like to prepare kebab.

Boiling

Select this cooking path if you want to boil pieces of meat that are usually cooked in liquid, such as prime boiled beef or terrines.

Pan-fry

Select this cooking path if you want to cook meat, which would typically be fried in the pan, or thinly diced meat.

Meatloaf

Select this cooking process if you would like to prepare meatloaf.

Lomo saltado

Select this cooking path if you would like to braise Peruvian Lomo Saltado or sliced beef.

Roast at low temperature

Select this cooking path if you want to fry pieces of meat with crackling or skin at low temperatures. Also select this cooking path, if you want to cook food overnight, or if you are not staying in the kitchen.

Nikomi

Select this cooking path if you would like to prepare Japanese Nikomi with instant noodles.

Breaded items

Select this cooking path if you would like to prepare breaded meat items.

Roast beef

Select this cooking process if you would like to prepare roast beef.

Sauté

Select this cooking path if you would like to sauté meat.

Braise

Select this cooking path when cooking braised dishes or braising finely diced meat, such as casserole. If you want to heat braised dishes to service temperature, select a suitable cooking path from the operating mode Finishing.

Tsukeyaki

Select this cooking path if you would like to prepare meat that has been marinated in Tsukeyaki sauce and is to be cooked in the ideal climate.

5.2.3 Fish

Fry

Choose this cooking process if you want to roast fish fillets or whole fish with or without skin, marinated or on a bed of vegetables.

Steam

Select this cooking process if you want to steam fish, fish fillets or terrines.

Chinese-style steamed dishes

Select this cooking process if you want to steam fish Chinese style.

Salt-baked fish

Select this cooking process if you would like to prepare salt-baked fish.

Deep-fry

Select this cooking process if you want to deep-fry fish.

Grill

Select this cooking path if you would like to grill fish fillets or whole fish with or without skin

Moqueca

Choose this cooking process if you want to prepare Brazilian Moqueca or other fish stews where the food is first fried and then filled with liquid.

Nizakana

Choose this cooking process if you want to poach fish, such as mackerel or herring, Japanese style in dashi.

Octopus

Select this cooking process if you want to cook octopus, squid or cuttlefish.

Breaded items

Select this cooking path if you would like to prepare breaded fish fillets or breaded fish.

Sauté

Select this cooking process if you want to sauté fish.

Braise

Select this cooking process if you want to braise fish.

Braise Chinese-style

Select this cooking process if you want to braise fish Chinese style.

Tsukeyaki

Choose this cooking process if you want to prepare fish marinated in Sukiyaki sauce and cooked in the ideal climate.

5.2.4 Egg dishes and desserts**Baked dessert**

Select this cooking path if you would like to prepare fresh, sweet bakes, like semolina or rice puddings, strudel, baked apples or Kaiserschmarrn. Select this cooking path if you would like to prepare convenience products.

Steam dessert

Select this cooking path if you would like to prepare steamed desserts, like steamed dumplings or yeast dumplings.

Frying eggs

Select this cooking path if you would like to prepare fried eggs, scrambled eggs or omelettes.

Steam/boiled eggs

Select this cooking path if you would like to prepare soft, soft-boiled or hard-boiled eggs or if you would like to poach eggs.

Poached eggs

Select this cooking process if you want to poach eggs.

Egg custard / flan

Select this cooking path if you would like to prepare egg custard, sweet or savoury flans.

Boil fruits

Select this cooking path if you would like to boil fruits in liquid.

Onsen tamago

Select this cooking process if you would like to prepare Onsen tamago.

Scrambled eggs

Select this cooking process if you want to cook scrambled eggs.

Fried eggs

Select this cooking process if you want to cook fried eggs.

5.2.5 Vegetables and side dishes

Sear

Select this cooking process if you want to fry vegetables and side dishes.

Savoury bakes

Select this cooking process if you want to prepare pasta or vegetable casseroles, paella or gratinated stuffed vegetables.

Baked potatoes

Choose this cooking process if you want to prepare baked potatoes from whole potatoes with the Potato Baker.

Baking/Convenience

Choose this cooking process if you want to prepare side dishes from thin convenience products that are usually prepared in the oven.

Biryani

Select this cooking process if you want to cook rice dishes such as Indian Biryani.

Congee

Select this cooking path if you would like to prepare congee or Chinese rice pudding.

Steam

Choose this cooking process if you want to steam vegetables, fresh or frozen side dishes, and whole potatoes.

Dim sum

Select this cooking path if you would like to prepare Chinese Dim Sum.

Double-boiled soup

Select this cooking process if you would like to prepare Chinese double-boiled soup.

Stew

Select this cooking process if you want to stew vegetables and side dishes, such as ratatouille, red cabbage or onions.

Preserve

Select this cooking process if you want to make fruit or vegetable preserves. To boil down the food, you need a reference container with a lid.

1. Pierce a hole in the lid of the reference container. Do not use the core temperature sensor for this.
2. Fill the food into the desired containers and close them with their lids.
3. Start the cooking process and load the device.
4. Insert the core temperature probe through the hole in the lid of the reference container.

The **Reduce** process controls to an F-value of 0.1. No semi-preserves are produced.

Deep-fry

Select this cooking process if you would like to deep-fry vegetables and side dishes.

Grill

Select this cooking process if you want to prepare vegetables and side dishes with a grill pattern.

Indian dal

Select this cooking process if you want to cook Indian dal, dried beans or legumes.

Itamemono

Select this cooking path if you would like to prepare Japanese Itamenmono.

Potato gratin

Select this cooking process if you want to prepare au gratin potatoes or other potato casserole dishes.

Dumplings

Select this cooking process if you want to prepare dumplings.

Macaroni casserole

Select this cooking path if you would like to prepare Norwegian macaroni casseroles.

Nimono

Select this cooking path if you would like to prepare Japanese Nimono.

Pasta with sauce

Choose this cooking process if you want to prepare short dried pasta, such as penne or tortellini, without precooking in the sauce. The noodles are ready for serving immediately after the end of the cooking process.

Chips

Select this cooking process if you want to prepare commercially available, pre-fried chips.

Fried rice

Select this cooking process if you want to prepare fried rice dishes.

Steam rice

Select this cooking path if you would like to steam rice or grains, like for example steaming pearl barley or couscous.

Sushi rice

Select this cooking process if you want to make sushi rice.

Dry

Select this cooking process if you want to dehydrate vegetables, mushrooms or fruit. To obtain an ideal result, cut the food to be cooked into thin slices.

Totopos

Select this cooking path if you would like to prepare Mexican totopos or tortilla chips.

5.2.6 Baked goods

Crisp up

Select this cooking path if you would like to bake either fresh or frozen baked goods or baked goods from the previous service.

Baguette

Select this cooking path if you would like to bake fresh or partly baked baguettes.

Puff pastry

Select this cooking path if you would like to prepare puff pastry or pies.

Bread

Select this cooking path if you would like to bake fresh or partly baked bread.

Bread rolls

Select this cooking path if you would like to bake fresh or partly baked bread rolls.

Cheesecake

Select this cooking path if you would like to bake New York cheesecake without browning. If you would like to bake a German cheesecake with different browning, select the cooking path Cheesecake.

Croissant

Select this cooking path if you would like to prepare croissants or pastries that need to be steamed before baking.

Eclairs

Select this cooking path if you would like to prepare delicate baked goods from choux pastry.

Macau egg tart

Select this cooking path if you would like to prepare Chinese egg tart Macau.

Roast

Choose this cooking path if you would like to ferment fresh or frozen yeast or sourdough.

Yeast cakes

Select this cooking path if you would like to bake cakes or pastries made from fresh yeast dough, e.g. yeast wreath, sweet yeast buns or fruit-filled yeast dough.

Cheesecake

Select this cooking path if you want to bake cheesecake with different browning levels. If you would like to bake a New York cheesecake, select the cooking path Cheesecake.

Biscuits

Select this cooking path if you are making shortbread biscuits, e.g. if you want to prepare biscuits, cookies or shortcrust pastry.

Cakes

Select this cooking path if you would like to prepare cakes and biscuit bases.

Soft pretzels

Select this cooking process if you want to make soft pretzels.

Meringue

Select this cooking path if you would like to prepare egg white bakes, for example meringue.

Muffin

Select this cooking path if you would like to bake muffins in the muffin and timbale shape.

Brazilian cheese bread

Select this cooking path if you would like to bake fresh or frozen Brazilian Pão de Queijo.

Danish pastry

Select this cooking path if you would like to prepare pastries that need to be steamed before baking, e.g. Danish pastries or bagels.

Pizza

Select this cooking path if you want to prepare pizza, filled dough or yeast dough on the grill and pizza plate.

Samosas

Select this cooking path if you would like to prepare Indian dumplings filled with curry.

Soft rolls

Select this cooking path if you want to bake pastries with a browned surface and a soft crust, for example when preparing burger buns or raisin rolls.

5.2.7 Finishing

Serving container

Select this cooking path if you would like to heat up cooked, chilled food in containers to a temperature suitable for consumption.

Heat through

Select this cooking path if you would like to heat up previously cooked dishes to the desired core temperature and keep them at this temperature.

Hold

Select this cooking path if you would like to keep food warm while serving.

À la carte plates

Select this cooking path to warm food that has already been plated to serving temperature in a la carte operations.

Plated banquet

Select this cooking path if you would like to provide many plates for the service at the same time, e.g. at conferences, weddings or catering events.

Crisp

Select this cooking path if you would like to heat up cooked dishes, like pork knuckle or crispy roasts, to the serving temperature.

5.3 Cooking food intelligently

5.3.1 Calling up intelligent cooking process

You can call up an intelligent cooking process in 3 ways:



- Via iCookingSuite
- Via the programming mode [▶ 63]
- Via the search assistant [▶ 95]

iCookingSuite

1. Press the button in the menu bar: 
 - > In the iCookingSuite, you can call up an intelligent cooking process in 3 ways:
 - Select the desired cooking mode, e.g. **vegetables and side dishes**.
 - Select the desired cooking method, e.g. **braising**.
 - Select the desired cooking mode and cooking method.

Once you have selected these, the corresponding intelligent cooking processes will be displayed.

Programming mode

1. Press the button in the menu bar: 
2. Press the button 
 - > All stored intelligent cooking processes will be displayed.



Search assistant

1. Press the button in the menu bar: 
2. Enter the name of the intelligent cooking process.
 - > The desired cooking process will be displayed.

5.3.2 Starting intelligent cooking process

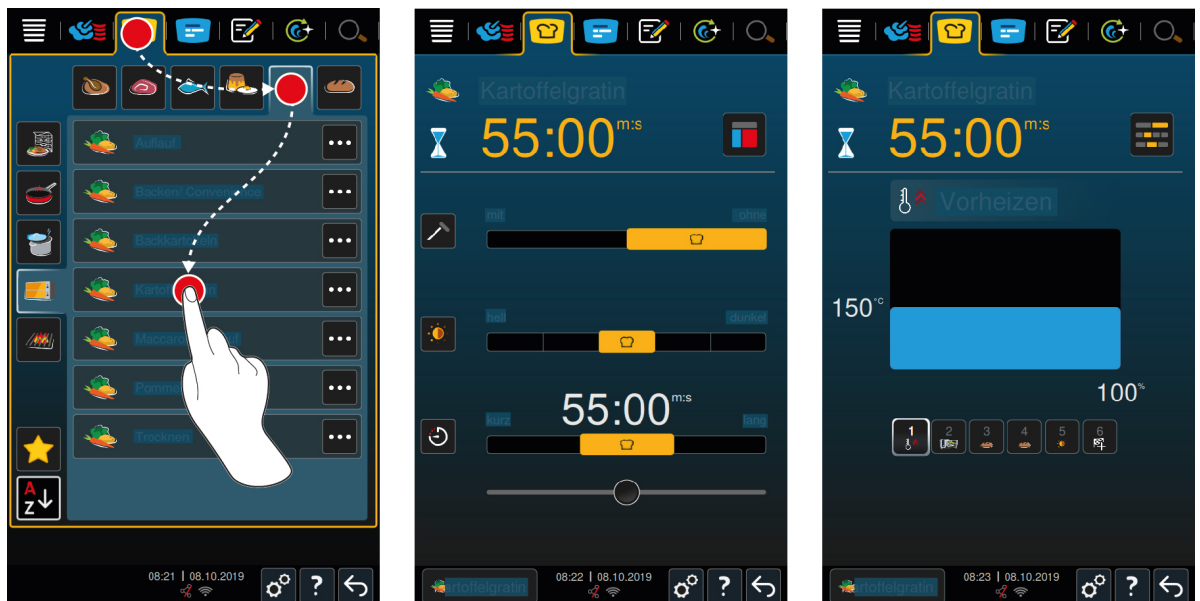
In this section, the **potato gratin** cooking process will be used to show how an intelligent cooking process runs. Please note that every intelligent cooking process leads to the desired result with different cooking parameters and the ideal sequence of cooking steps.



1. Press the button in the menu bar: 
2. Press the button 
3. Press the button **Potato gratin**
 - > The intelligent cooking process will start and the cooking cabinet will be preheated to the defined climate.
4. Set the desired cooking result using the cooking parameters [▶ 37].
 - > After a short time, the display in the Cockpit [▶ 41] will switch.
 - > Once the set climate has been reached, you will be prompted to load the unit.
5. Load the unit.
6. Close the cooking cabinet door.

- > The cooking process will continue.
7. Follow the prompts of the unit.
 - > When the cooking time has elapsed or the core temperature has been reached, an acoustic signal will ask you to check whether the food has reached the desired result.
 8. If the cooking result meets your requirements, take the food out of the cooking cabinet.
 9. If the cooking result does not yet meet your requirements, continue the cooking process with one of the suggested options.

5.4 Adjusting cooking result to own requirements

Depending on which intelligent cooking process you have selected, different cooking parameters and functions will be displayed. The cooking processes use standard settings for your country in order to achieve the ideal cooking results. You can adjust these cooking parameters to your requirements with simple moves [▶ 17] or the central dial [▶ 17] and select additional functions. Depending on these settings, the cooking process workflow will vary. You can monitor the sequence at any time in the Cockpit [▶ 41].

5.4.1 Cooking parameters



Frying level

With these cooking parameters, you can set whether you want to sear the food or not. Select any level to adjust the searing intensity to your requirements. The lower the searing level, the less the cooking losses will be. If you select **without**, the **searing** cooking step will be skipped. Select **without** if you want to gently cook through smaller already seared meat pieces.

If you need to crisp the food at the end of the cooking process, select a lower searing level.

The very high searing temperatures safely kill the bacteria on the exterior of the food. This means that food is cooked perfectly hygienically even at a lower core temperature.



Browning

With this cooking parameter, you can set how brown the surface of the food should be. Select any level to adjust the intensity of the browning to your requirements. Food that is marinated with spices, herbs or pastes that support browning will brown quicker and more intensely. In these cases, select a lower browning level.



Food thickness

With this cooking parameter, you can set whether the food is thin or thick. Select **thin** for food thinner than 2 cm. Select **thick** for food thicker than 2 cm.



Size of food

With this cooking parameter, you can set how large the food is.

- Select **small** for fillet strips or quail breasts. Select **large** for roast beef, whole duck or pork belly.
- Select **small** for eggs weighing less than 53 g. Select **large** for eggs weighing more than 64 g.



Cooking cabinet humidity

With this cooking parameter, you can set the humidity in the cooking cabinet.

If you would like to finish or cook food sous-vide, select the following settings:

Level	Suitable for
Level 1 – dry	Select this level if you want to cook food that does not require any additional humidity, e.g. breaded food or chips.
Stage 2	Select this level if you want to cook food that requires a little additional humidity, e.g. stewed vegetables.
Stage 3	Select this level if you want to cook different foods at the same time.
Level 4 – humid	Select this level if you want to cook food that requires a lot of additional humidity, e.g. rice or poached fish.



Cabinet temperature

With this cooking parameter, you can set the temperature in the cooking cabinet.

You can view the current cooking cabinet humidity and cooking cabinet temperature as follows:

1. Press and hold the button:
 - > After 10 seconds, the current cooking cabinet temperature will be displayed.
2. To revert to the set parameter values, release the button.



Cooking time

With this cooking parameter, you can set the time in which the food will reach the desired cooking result or the desired cooking level. In most intelligent cooking processes, you can let your unit run uninterrupted with the settings you apply. To do this, switch on continuous operation.

1. Select the level marked with **Continue**.

If you have set the cooking time, the **core temperature** cooking parameter will not be available.



Core probes

With this cooking parameter, you can set whether the food is to be cooked with or without the core probe. You can then set the desired core temperature of the food.



Core temperature

With this cooking parameter, you can set how high the core temperature or the cooking level of the food should be.

Please adhere to the applicable hygiene regulations for the relevant food in your country when setting the core temperature.

Cooking level

With this cooking parameter, you can set the cooking level of the food. Every cooking level is assigned to a core temperature which you can adjust to your requirements. If you want to cook food using low temperature cooking, the core temperature is up to 10 °C lower than in other cooking methods. If you are cooking poultry, always ensure a hygienic core temperature of at least 72 °C. Please adhere to the HACCP regulations for your country.



Delta-T cooking

With this cooking parameter, food is cooked while maintaining a constant difference between cooking cabinet temperature and core temperature. By slowly increasing the cooking cabinet temperature with a constant difference with the core temperature, the food is cooked slowly and very gently. This minimises cooking losses. You can set a difference between 10 °C and 60 °C. Then you must set the desired core temperature.

The smaller the difference between the cooking cabinet temperature and the core temperature, the slower and more gently the food will be cooked. The bigger the difference between the cooking cabinet temperature and the core temperature, the faster the food will be cooked.



Cooking speed

With this cooking parameter, you can set the temperature control in the cooking cabinet. If you select **low**, food is cooked for a long time at low temperatures. If you select **normal**, food is cooked at higher temperatures and in a shorter time.

5.4.2 Additional functions



Cooking cabinet humidity

With this additional function, you can set the humidity in the cooking cabinet. There are 2 available levels. The higher the selected level, the more humidity will be in the cooking cabinet, and the humidity level is higher throughout the entire cooking process.

If you want to cook food that does not require any additional humidity, press the button:  No additional humidity will be added to the cooking cabinet.

**Roast**

With this additional function, leave the food in the cooking cabinet to prove at the optimal temperature. There are 5 available levels. The higher the selected level, the longer the food will prove in the cooking cabinet. If you want to cook food without a proving phase, press the button:

**Humidification**

With this additional function, water will be sprayed onto the heating element by the moistening nozzles during cooking. The surface of the food is humidified, the steam condenses and you get crispy crusts on your rolls and optimal oven operation. The cooking cabinet temperature must be between 30 – 260 °C.

1. Press and hold the button:

>> The moistening nozzles will spray water onto the fan wheel for as long as you press the button.

**Flash steam**

With this additional function, humidity is added to the cooking cabinet at the start of the baking process. The surface of the food is humidified, the steam condenses and you get crispy crusts on rolls and optimal oven operation. The higher the selected level, the more humidity will be added to the cooking cabinet. If you want to the cook food without flash steaming, press the button:

**Air speed**

With this additional function, you can set the speed of the fan wheel. There are 2 available levels. The higher the selected level, the higher the air speed will be. Select a lower level for small delicate foods.

5.4.3 Prompts**Abort**

All running cooking processes will be aborted

**Load**

You will then be prompted to load the unit with food.

**Confirm**

You will be prompted to confirm an action.

**Brushing**

You will be prompted to brush the food, e.g. baked goods with egg.

**Carve**

You will be prompted to cut into the food, e.g. rinds or baked goods.

Reset core probe

You will be prompted to re-insert the core probe into the food.

**Core probe in food**

You will be prompted to insert the core probe into the food.

**Pierce**

You will be prompted to pierce the food.

**Fill up**

You will be prompted to fill up the container with liquid, e.g. for braised dishes.

5.4.4 Information

During a cooking process, the cooking steps the unit is currently performing will be displayed.



Preheat

The unit will be preheated to the temperature that is set either as the standard setting in the manual modes or in the intelligent cooking processes.



Residual time

The intelligent cooking process stills needs the time displayed to finish.



Cooking process end

The end of the cooking process has been reached.

5.4.5 Options

If you have started a cooking path, all the available options are displayed. You can already select the **Overcrust** and **Maintain** options when the cooking path is running. You can only select the options **Change core temperature probe**, **New batch**, **Continue with time** and **Heat up to output temperature** when the end of the cooking path has been reached.



Hold

With this option, either the cooking cabinet climate or the core temperature of the food is held for a certain time. If you select this option, the food will be held at the preset cooking cabinet temperature or the core temperature for up to 24 hours. This prevents overcooking. To keep cooking losses as low as possible, it is recommended that the food only be left in the cooking cabinet with the **Hold** option for a short time.

In some cooking processes, such as overnight boiling, the **Hold** option is the last cooking step and is automatically started once the desired cooking result has been achieved. If you are cooking food of different sizes, plan a longer hold phase so that all the pieces of food reach the desired core temperature.

Well-matured meat, smaller meat pieces and game should not stay in the cooking cabinet with the **Hold** option for too long. Very young and insufficiently matured beef will on the other hand become tender.

1. To adjust the parameters of the **Maintain** option, press the button: 
2. Adjust the parameters as required.

>> When the end of the cooking path has been reached, the **Maintain** cooking step is automatically started.



Move

Select this option if you are cooking foods of different sizes or different foods with different cooking levels using the core probe:

1. If the set core temperature is reached, open the cooking cabinet door.
2. Insert the core probe into a larger piece of the food or the food with the higher core temperature.
3. Remove all the smaller pieces of the food from the cooking cabinet.
4. Close the cooking cabinet door.
5. Press the button 
 - > A window appears in which you can set the core temperature.
6. Select the desired core temperature.

>> Your setting will be applied automatically after just a few seconds.

Repeat this step until all the food has reached the desired core temperature.



New batch

With this option, you can load the unit with a new batch and continue the cooking process with the defined cooking parameters. First you will be asked to unload the unit and then load it again. When you have loaded the unit with a new batch and you close the cooking chamber door, the cooking path continues.



Time continued

With this option, the cooking process will continue for a certain time. If you select the option at the end of the cooking path, a window appears where you can set how long you would like the cooking path to be continued for.

1. Select the desired duration.

>> Your setting will be applied automatically after just a few seconds.

If you switch from the cockpit back to the cooking parameters, the overview is greyed out. You cannot change the cooking parameters. Once the time you have set has expired, you can either unload the unit or continue the cooking path with an option.



Crisp

With this option, food is crisped to produce crispy crusts and roast aromas.

In mixed loads, take the food you do not want to crisp out of the unit. Then start the **Crisping** option.

If you have cooked food in containers and some liquid fat has accumulated during cooking, replace the container before starting the **Crisping** option. This prevents the build up of unnecessary smoke during crisping.

If the food does not have the desired crust or colour after crisping, select the **Time continued** option. You can then set how much longer the food should crisp for.

Rare food is not suitable for crisping. The high temperature would produce grey edges.

1. To adjust the parameters of the **Overcrust** option, press the button: 

2. Adjust the parameters as required.

>> When the end of the cooking path has been reached, the **Overcrust** cooking step is automatically started.

5.5 Monitor the intelligent cooking path

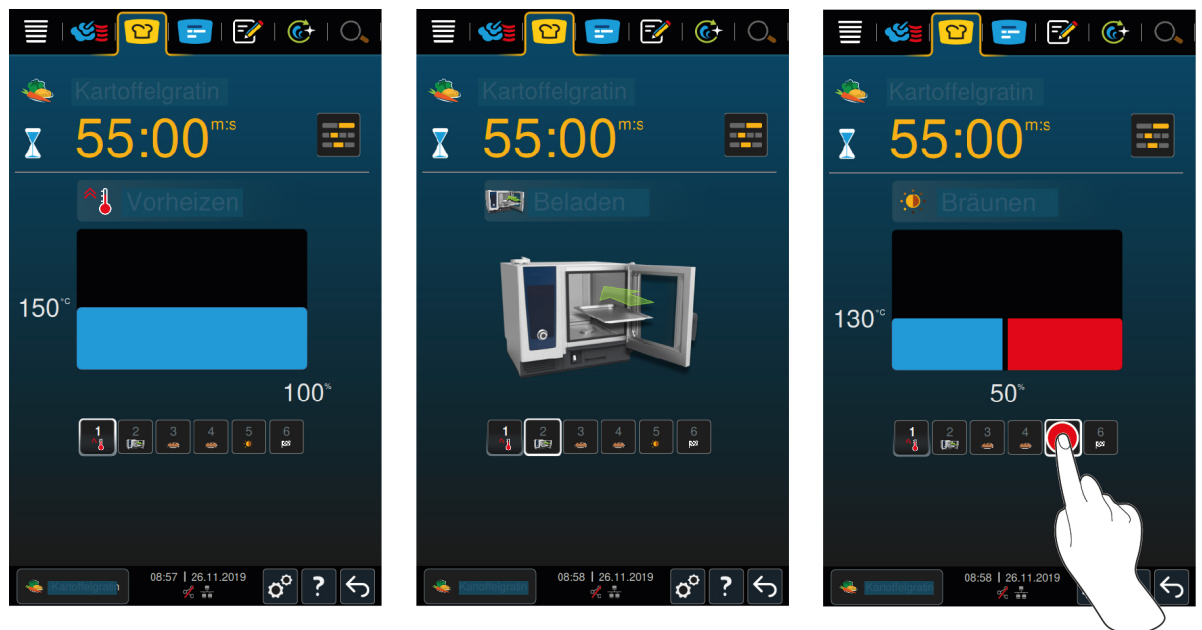

If you have started an intelligent cooking path, the display changes to the cockpit after a short time. All cooking steps that the intelligent cooking path processes are displayed here one after the other. The active cooking step is highlighted. The cooking steps that will take place in the future are greyed out. When the cooking step is completed, the next cooking step is automatically displayed.

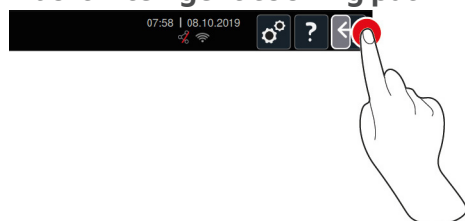

5.6 Abort intelligent cooking path



1. Press and hold the button: 
 - > The cooking path is cancelled. The start screen will appear.

5.7 Arrange intelligent cooking paths

In the iCookingSuite, you can either arrange the intelligent cooking paths alphabetically or according to the frequency of use.

1. To arrange the intelligent cooking paths alphabetically, press the button: ↓
2. To arrange the intelligent cooking paths according to the frequency of use, press the button: 

6 Manual cooking



With the manual modes, the iCombi Pro supports you in your personal craft.

By selecting this mode, you set the climate and select whether you want to cook the food in steam, with convection heat or with a combination of steam and convection. Then you set the cooking cabinet temperature, the air speed and cooking time and make all the necessary decisions yourself. This gives you control to ensure the food is cooked exactly as you want it.

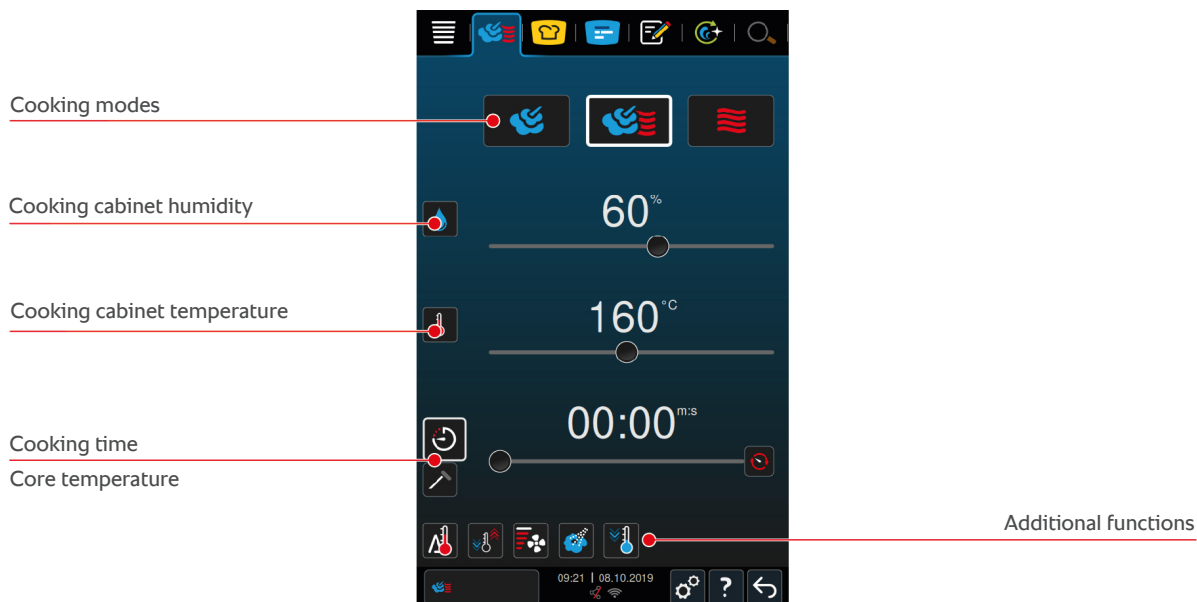

6.1 Adjusting cooking result to own requirements

6.1.1 Cooking parameters



Cabinet temperature

With this cooking parameter, you can set the temperature in the cooking cabinet. If you set the temperature to boiling temperature in the **Steam** mode, the following symbol will be displayed:

You can view the current cooking cabinet humidity and cooking cabinet temperature as follows:

1. Press and hold the button:
 - > After 10 seconds, the current cooking cabinet temperature will be displayed.
2. To revert to the set parameter values, release the button.



Cooking cabinet humidity

With this cooking parameter, you can set the humidity in the cooking cabinet.

- In the **Steam** mode, the cooking cabinet humidity is 100 % and cannot be changed.
- In the **Combination of steam and hot air mode**, extra humidity is injected by the steam generator in addition to the humidity from the food. If the set cooking cabinet humidity is exceeded, the cooking cabinet will be dehumidified.
- In the **Hot Air Mode**, the humidity is not injected by the steam generator, but comes from the food. If the set cooking cabinet humidity is exceeded, the cooking cabinet will be dehumidified.



Cooking time

With this cooking parameter, you can set the time in which the food will reach the desired cooking result. If you have set the cooking time, the **core temperature** cooking parameter will not be available.

Alternatively, you can let your unit run uninterrupted with the settings you apply. To do this, select continuous operation.

1. If you want to operate your unit in continuous operation, press either on  or slide the cooking time regulator fully to the right until the following message is displayed: **Continuous operation**



Core temperature

With this cooking parameter, you can set how high the core temperature of the food should be. If you have set the core temperature, the **cooking time** cooking parameter will not be available.

6.1.2 Additional functions



Delta-T cooking

With this additional function, food is cooked while maintaining a constant difference between the cooking cabinet temperature and core temperature. By slowly increasing the cooking cabinet temperature with a constant difference with the core temperature, the food is cooked slowly and very gently. This minimises cooking losses. You can set a difference between 20 °C and 60 °C. Then you must set the desired core temperature.

The smaller the difference between the cooking cabinet temperature and the core temperature, the slower and more gently the food will be cooked. The bigger the difference between the cooking cabinet temperature and the core temperature, the faster the food will be cooked.



Create climate

With this function, the cooking cabinet temperature is adjusted to the target value of a cooking process. If you switch cooking processes, e.g. from grilling to baking food, the cooking cabinet will be cooled. If you switch from baking to grilling, the cooking cabinet will be heated.



Air speed

With this additional function, you can set the speed of the fan wheel. The higher the selected level, the higher the air speed will be. Select a lower level for small delicate food.



Humidification

With this additional function, water will be sprayed onto the heating element by the moistening nozzles during cooking. The surface of the food is humidified, the steam condenses and you get crispy crusts on your rolls and optimal oven operation. The cooking cabinet temperature must be between 30 – 260 °C.

1. Press and hold the button: 

>> The moistening nozzles will spray water onto the fan wheel for as long as you press the button.



Cool-down function

If you have cooked food at high temperatures, and then need a lower cooking cabinet temperature, you can cool down the cooking cabinet using the cool down function.

✓ The air baffle is correctly locked.

1. Press the button 

> Select the temperature to which the cooking cabinet should be cooled.

2. **⚠ WARNING! Scalding hazard! When you open the cooking cabinet door, hot steam will surge out of the cooking cabinet.** Open the cabinet door.

>> **⚠ WARNING! Risk of injury! When you open the cooking cabinet door, the fan wheel will not stop. Do not reach into the cabinet, rotating fan wheel.** The speed of the fan wheel will increase. The cooking cabinet will be cooled.

6.1.3 Prompts and information

During the cooking process, you may see the same prompts and information [▶ 40] as in intelligent cooking processes.



6.2 Steam

6.2.1 Cooking climate and temperature range

Cooking cabinet climate	Cooking methods	Cooking cabinet humidity	Cabinet temperature
moist	<ul style="list-style-type: none"> ▪ Steam ▪ Stew ▪ Blanch ▪ Heat through ▪ Soak ▪ Sous-vide cooking [▶ 49] ▪ Defrost ▪ Preserve 	100 %	30 – 130 °C

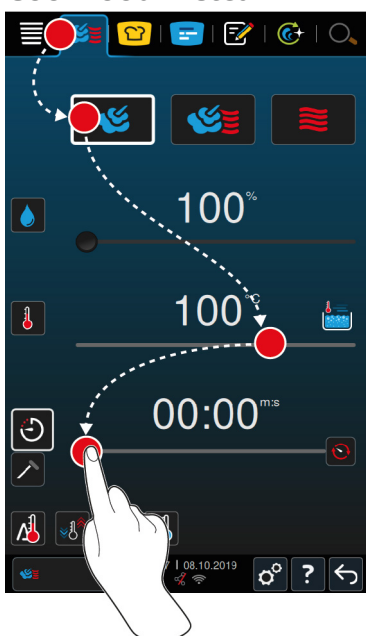
6.2.2 Cook food in steam



1. Press the button in the menu bar: 
2. Press the button
 - > The unit is heating up.
3. Set the desired cooking cabinet temperature.
4. To cook food with the cooking time, press the button: 
5. Set the cooking time.
6. To cook the food with the core temperature, press the button: 
7. Set the core temperature.
 - > Once the set cooking cabinet temperature has been reached, you will be prompted to load the unit.
8. Load the unit.
 - >> The cooking process will continue. If the cooking time has elapsed or the core temperature has been reached, an acoustic signal will ask you to check whether the food has reached the desired result.

6.3 Combination of steam and convection heat





6.3.1 Cooking climate and temperature range

Cooking cabinet climate	Cooking methods	Cooking cabinet humidity	Cabinet temperature
humid and hot	<ul style="list-style-type: none"> ▪ Bake ▪ Fry 	0 - 100 %	30 – 300 °C

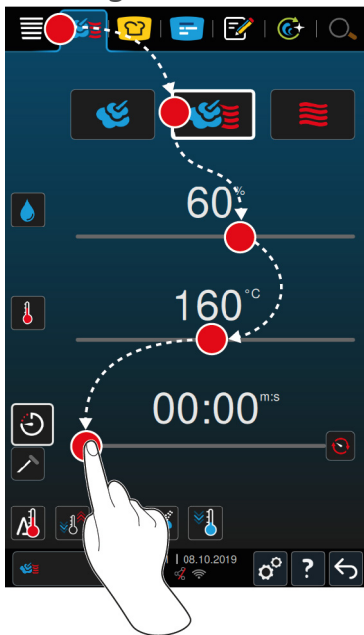
If the cabinet temperature is above 260 °C for 30 minutes, the temperature will be automatically reduced to 260 °C if you do not work with the unit within this period. If you perform an action within these 30 minutes, such as opening the cooking cabinet door, then the cooking cabinet temperature will be held at 260 °C for another 30 minutes.

6.3.2 Cooking the food in the combination of steam and hot air



1. Press the button in the menu bar: 
2. Press the button 
 - > The unit is heating up.
3. Set the desired steam saturation.
4. Set the desired cooking cabinet temperature.
5. To cook food with the cooking time, press the button: 
6. Set the cooking time.
7. To cook the food with the core temperature, press the button: 
8. Set the core temperature.
 - > Once the set cooking cabinet temperature has been reached, you will be prompted to load the unit.
9. Load the unit.
 - >> The cooking process will continue. If the cooking time has elapsed or the core temperature has been reached, an acoustic signal will ask you to check whether the food has reached the desired result.

6.4 Convection

6.4.1 Cooking climate and temperature range





Cooking cabinet climate	Cooking methods	Cooking cabinet humidity	Cabinet temperature
hot	<ul style="list-style-type: none"> ▪ Bake 	0 - 100 %	30 – 300 °C

Cooking cabinet climate	Cooking methods	Cooking cabinet humidity	Cabinet temperature
	<ul style="list-style-type: none"> ▪ Fry ▪ Grill ▪ Deep-fry ▪ Gratinata ▪ Glaze 		

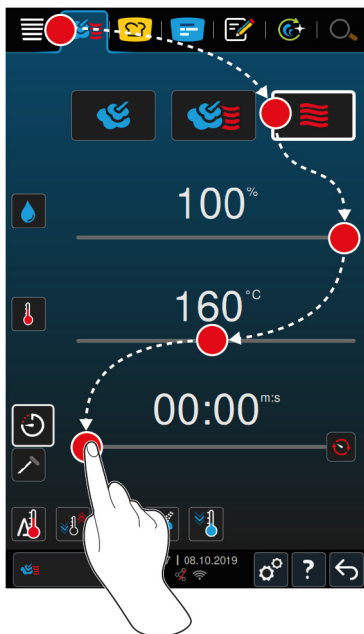
If the cabinet temperature is above 260 °C for 30 minutes, the temperature will be automatically reduced to 260 °C if you do not work with the unit within this period. If you perform an action within these 30 minutes, such as opening the cooking cabinet door, then the cooking cabinet temperature will be held at 260 °C for another 30 minutes.

6.4.2 Cook food in convection heat



1. Press the button in the menu bar: 
2. Press the button 
 - > The unit is heating up.
3. Set the desired cooking cabinet temperature.
4. To cook food with the cooking time, press the button: 
5. Set the cooking time.
6. To cook the food with the core temperature, press the button: 
7. Set the core temperature.
 - > Once the set cooking cabinet temperature has been reached, you will be prompted to load the unit.
8. Load the unit.
 - >> The cooking process will continue. If the cooking time has elapsed or the core temperature has been reached, an acoustic signal will ask you to check whether the food has reached the desired result.

6.5 Abort manual cooking

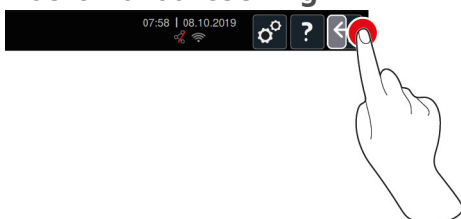

1. Press and hold the button: 
 - > The cooking process is cancelled. The start screen will appear.

7 Sous-vide cooking

In sous-vide cooking, food is prepared, seasoned, marinated or seared, vacuum-packed in a sous-vide bag and then cooked. This intensifies the food's own flavour, preserves the natural colours, precious vitamins and minerals are retained and cooking losses are reduced thanks to the gentle cooking. After cooking, the food must be cooled. Before the food is served, it is reheated still in the plastic bag, then removed from the bag and then finished according to the final dish.

Sous-vide cooking is particularly suitable for the following uses:

- **Cook and chill**
Produce your dishes centrally in a production kitchen and then deliver the dishes to satellite kitchens. This avoids expensive over-production, as you only finish the dishes you actually need.
- **Room service**
Produce your dishes or individual components, cool them down and finish the individual portions to order. This means even untrained kitchen staff can cater for your guests 24 hours a day.
- **Special diets and clean eating**
Gently produce healthy dishes and preserve the natural flavours and aromas. With the addition of aromatics, even unsalted dishes can taste naturally rich.

8 Low temperature cooking

Cooking large meat and poultry products requires a great deal of supervision work and many years of cooking experience. Your units are also blocked for hours. With your cooking system, you can face these challenges with ease: You can slowly roast, boil or braise food at low temperatures during low-production periods, such as in the afternoon or in non-service periods. This means you can make full use of your unit for up to 24 hours a day. And if you cook food overnight, you can also save energy by using night tariffs.



TIP

If there is a power cut during a low temperature cooking process, the cooking process will be interrupted. If the power cut lasts less than 15 minutes, the cooking process will continue. If the power cut lasts longer than 15 minutes, the unit will switch to standby mode after the power cut. You must restart the cooking process to finish cooking the food.

9 Finishing

Using Finishing, you can separate your food production from service and thus give yourself some freedom for the important things in cooking: planning, menu design or creative plating. Quality losses from keeping food warm are minimised and perfect food quality is assured.



- Only finish the foods that you actually need, adjust the required food to your guest numbers.
- Avoid rushing and stress when plating thanks to shorter production and service times.
- Reduce staff costs with efficient time management and shorter paths to the guest.
- Hold multiple events simultaneously and increase your occupancy, without any additional costs.

With Finishing, you can produce perfect food quality in a wide variety, whether in a restaurant, hotel or industry catering:

- **Finishing in a restaurant**
The food is finished exactly when you need it.
- **Finishing in a hotel**
Plated Finishing is particularly ideal when you need to serve many plates at the same time, e.g. at conferences, weddings or catering events.
- **Finishing in industry catering**
Container Finishing is ideal when you need to offer a wide variety of food in large quantities.



9.1 Adjust plate weight à la carte

Before you start the finishing, set how heavy an empty plate is. With the help of this information, the unit will adjust the cooking steps, so that you achieve an ideal finishing result and no moisture condenses on the plates.

1. Press the button 
2. Press the button  **Cooking**
3. Press the button  **À la carte plate weight**
4. Select one of the following values:
 - <700 g
 - 700 g – 899 g
 - 900 g – 1099 g
 - >1100 g

9.2 Adjust banquet plate weight

Before you start the finishing, set how heavy an empty plate is. With the help of this information, the unit will adjust the cooking steps, so that you achieve an ideal finishing result and no moisture condenses on the plates.

1. Press the button 
2. Press the button  **Cooking**
3. Press the button  **Banquet plate weight**
4. Select one of the following values:
 - <700 g
 - 700 g – 899 g
 - 900 g – 1099 g
 - >1100 g

10 iProductionManager



The iProductionManager organises the entire production process intelligently and flexibly. This includes which products can be cooked together, the optimal preparation sequence of the dishes and the monitoring of the cooking path.



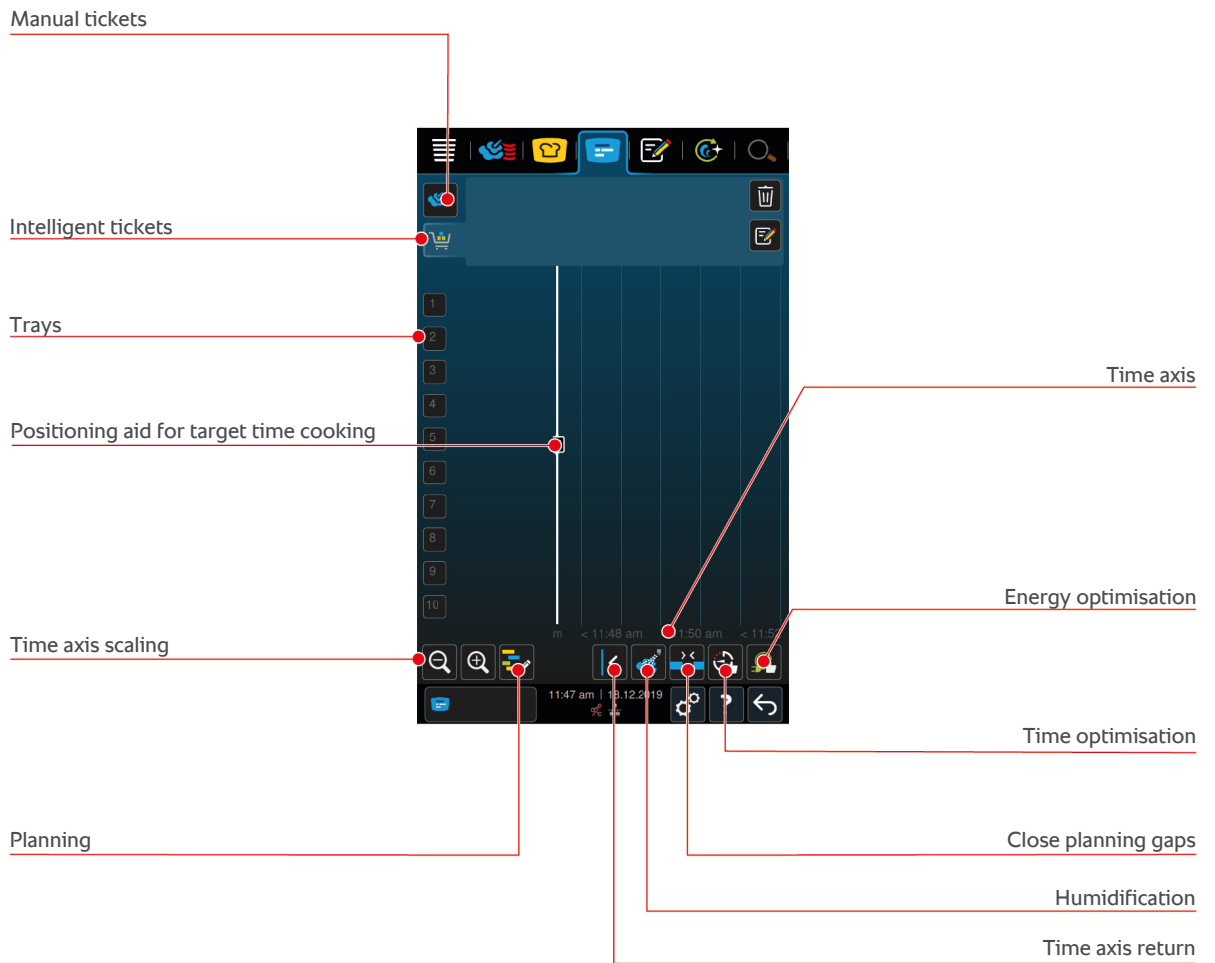



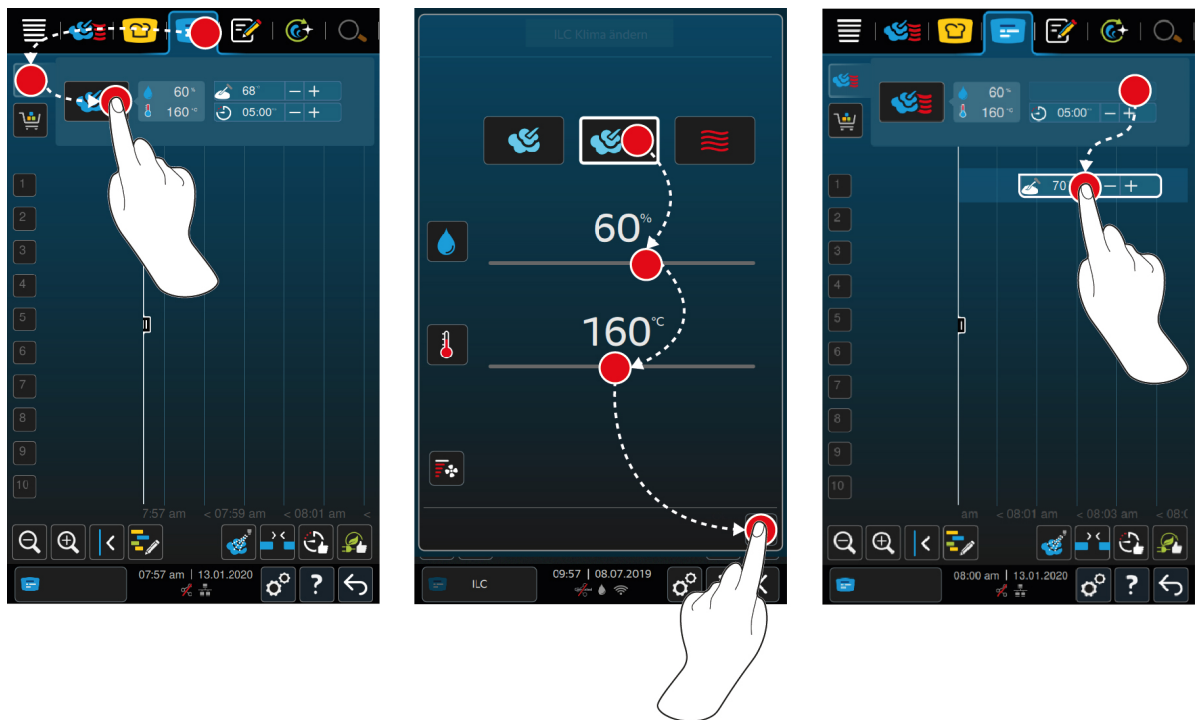

The iProductionManager will remind you when a product needs to be loaded or taken out. You can decide whether the food is cooked energy-optimised, time-optimised or with a specific target time. Accordingly, the iProductionManager intelligently arranges the preparation order of the dishes. For you this means that you always have everything under control, without checking or monitoring, therefore achieving high efficiency in your food production.



10.1 Create manual tickets

You can add manual tickets to the iProductionManager. You first set the climate and then choose if the ticket should be created using the cooking time or the core temperature. Please note: If you are cooking food with the integrated core temperature probe, you can only place one manual core temperature ticket on the time axis at one time.









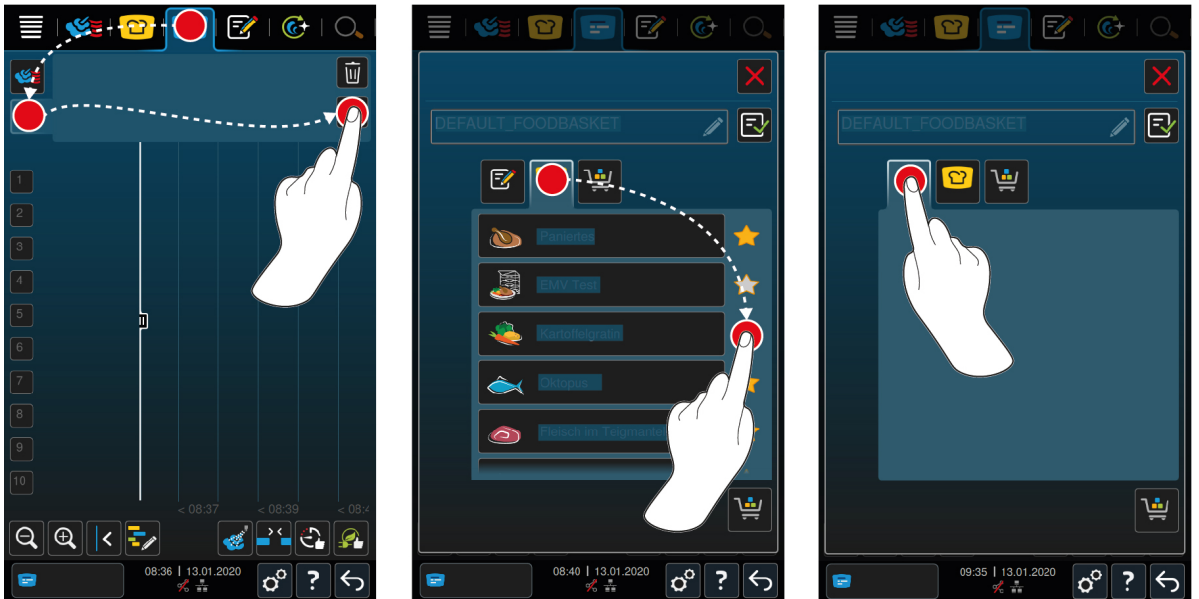

1. Press the button in the menu bar: 
 2. Press the button 
 3. Select the operating mode, Steaming [▶ 45]  , Combination of steaming and convection heat [▶ 46]  or Convection heat [▶ 46] 
 4. Adjust the cooking parameters as required. You can also set the speed of the fan wheel. To do this, press this button: 
 5. To save your changes, press the button: 
 6. If you want to increase or decrease the core temperature or increase or decrease the cooking time, either turn the central setting wheel or press the buttons:  or 
 7. Press the button repeatedly until the desired setting is reached.
- >> You can now place the ticket [▶ 56].

10.2 Create shopping carts

You can send shopping carts that have already been created from the programming mode [▶ 67] to the iProductionManager or create your own shopping carts in the iProductionManager.



1. Press the button in the menu bar: 
2. Press the button 
3. Press the button 
4. To add intelligent cooking paths to the shopping cart, press the button: 
 - > All intelligent cooking paths are displayed.
5. Scroll through the list and press the desired cooking path.
 - > The cooking path is highlighted with  and added to the shopping cart.
6. To add programmes from the programming mode to the shopping cart, press the button: 
 - > All saved programmes are displayed.
7. Scroll through the list and press the desired programme.
 - > The programme is highlighted with  and added to the shopping cart.
8. To give the shopping cart a name, press the button: 

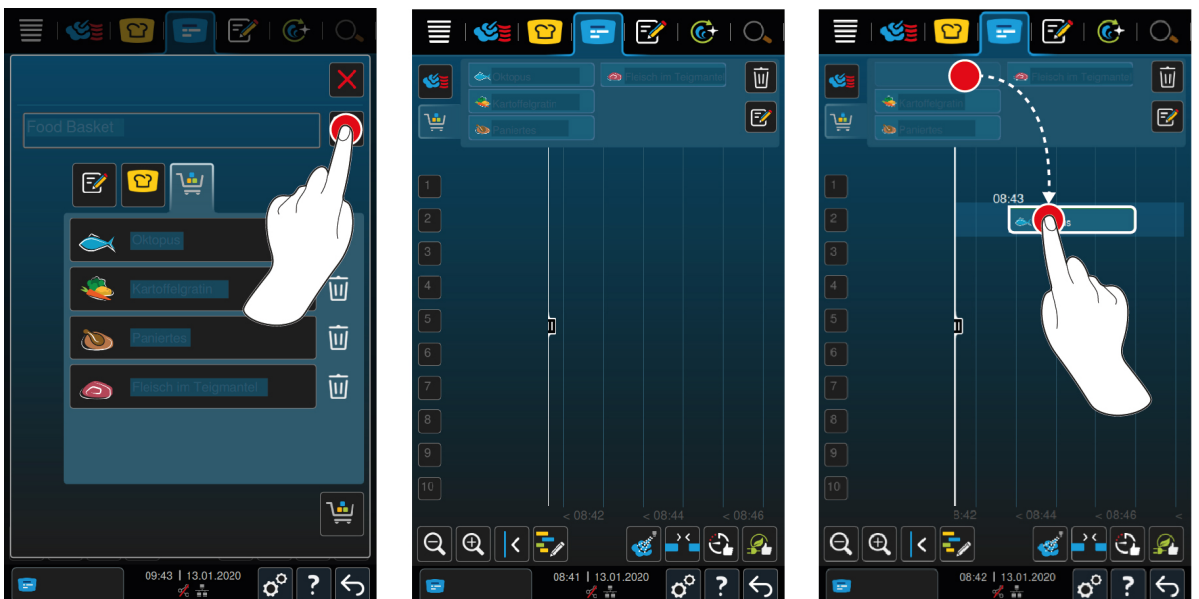

9. To save the shopping cart permanently, press the button: 
- >> The shopping cart is displayed in the programme list of the programming mode. You can now place the ticket [▶ 56].

>> You can find more information about shopping carts here: Edit and delete programmes [▶ 67]







10.3 Edit ticket board

You can add any intelligent cooking path or ticket you want to the ticket board. If you do not save the configuration as a shopping cart, the ticket board will be overwritten as soon as you upload a new shopping cart.

iProductionManager







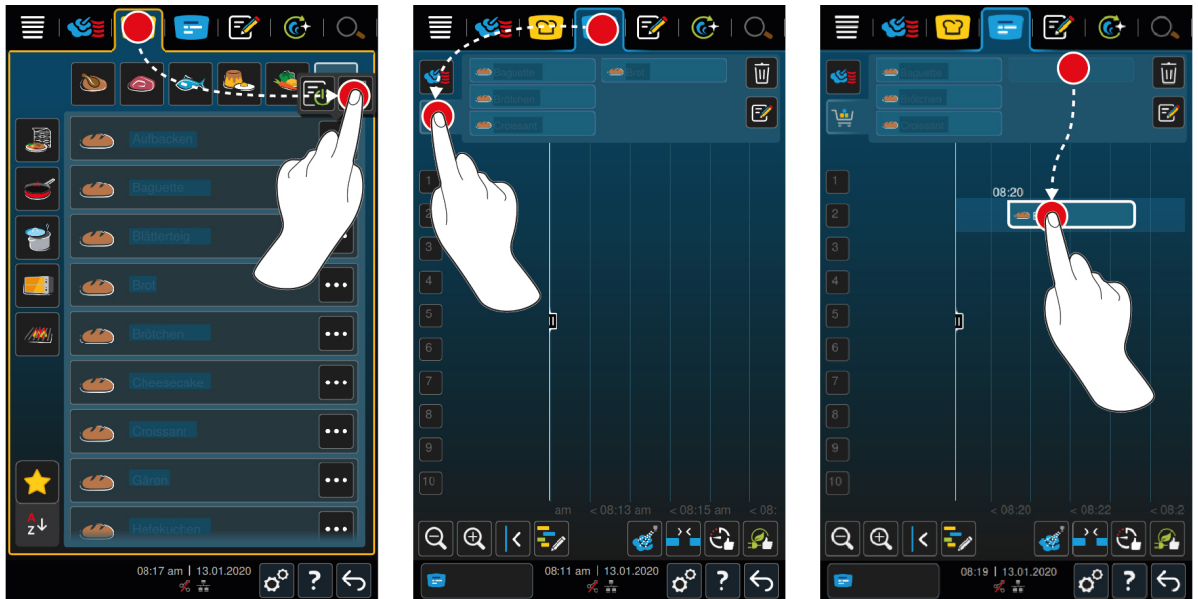

✓ You have sent a shopping cart from the programming mode to the iProductionManager.

1. Press the button 
 2. To add intelligent cooking paths to the shopping cart, press the button: 
 - > All intelligent cooking paths are displayed.
 3. Scroll through the list and press the desired cooking path.
 - > The cooking path is highlighted with  and added to the shopping cart.
 4. To add programmes from the programming mode to the shopping cart, press the button: 
 - > All saved programmes are displayed.
 5. Scroll through the list and press the desired programme.
 - > The programme is highlighted with  and added to the shopping cart.
 6. Press the button 
- >> The intelligent cooking paths or tickets are displayed on the ticket board. You can now place the ticket [▶ 56].

iCookingSuite and programming mode



1. To send an intelligent cooking path from the iCookingSuite to the iProductionManager, press the button in the menu bar: 
2. Press the button underneath the desired cooking path: ...
3. Press the button 
4. To send a cooking path from the programming mode to the iProductionManager, press the button in the menu bar: 
5. Press the button underneath the desired cooking path: ...
6. Press the button 
7. Press the button in the menu bar: 
8. Press the button 
 - > The intelligent cooking paths are displayed in the ticket board. You can now place the ticket [▶ 56].

10.4 Place ticket

- ✓ You have created manual programme [▶ 52], shopping cart [▶ 53] or a programme board [▶ 55].
1. Drag a ticket to the desired shelf level.
 - > For better orientation, the shelf level where you want to place the ticket is highlighted in blue. As a further help, the time is shown on the ticket.
 - > If the shelf level is marked in yellow or red, you cannot place the ticket without moving the already placed tickets. Click here for more information: Combination check [▶ 57] and locating logic [▶ 57]
 2. If you have placed several tickets, review the time axis to get an overview. To do this, press this button: 

The following options are available to optimise the placement of tickets:

- Close planning gaps [▶ 57]
- Time optimisation [▶ 58]
- Energy optimisation [▶ 59]
- Target time cooking [▶ 60]

If you place tickets at the actual time, a vertical yellow or blue bar appears:

- A yellow bar indicates that the cooking chamber is heating up.
- A blue bar indicates that the cooking chamber is cooling down using the cool-down function.
- The width of the bar indicates how long it takes to heat up or cool down.

When the desired temperature is reached, you will be asked to load the unit. The symbol  appears next to the shelf level.

After you have loaded the unit, the shelf level shows how long the food stays in the cooking chamber.

When the cooking process of the ticket is finished, you will be asked to unload the unit. The symbol  appears next to the shelf level. The cooking time is 00:00.

10.4.1 Combination check

Each ticket that you want to place in the iProductionManager is checked to see if the new ticket matches the tickets already placed and if they can be placed at the desired time. The tickets are separated based on the following 3 values and checked independently:

- An operating mode is assigned to each ticket. It is checked whether the operating modes fit together.
- A cooking chamber temperature is assigned to each ticket. It is checked whether the cooking chamber temperatures match.
- A cooking chamber humidity is assigned to each operating mode. It is checked whether the cooking chamber humidity levels match.

Both manual operating modes and intelligent cooking paths are tested for their compatibility. You can only combine cooking paths that are cooked in the same climate. Cooking paths that go through different climates, like for example low temperature roasts cannot be combined with other tickets.

10.4.2 Placement logic

Based on the combination check, the iCombi Pro decides in which position the ticket will be placed. Depending on the result of the check, the tickets are optimally placed in the iProductionManager. The iProductionManager uses a coloured marking on the shelf levels to indicate if a new ticket has an effect on already placed tickets:

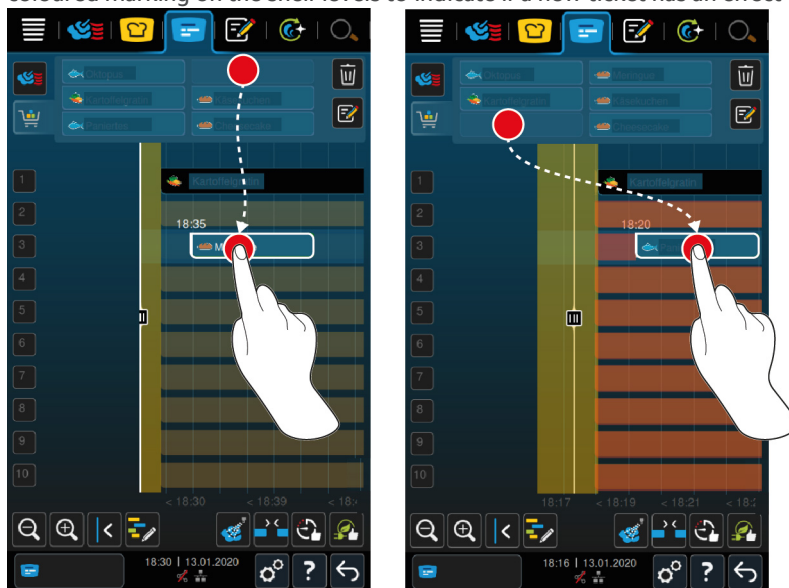

- If the shelf levels are marked in yellow, you can place a ticket, but other already placed tickets are moved.
- If the background is red, you cannot place the ticket, because a ticket is already being processed.

If you move a ticket, the entire block where the ticket was placed after the combination check is moved.

10.4.3 Close planning gaps

You can programme your unit to automatically close the time gaps that arise when placing tickets across all shelf levels.

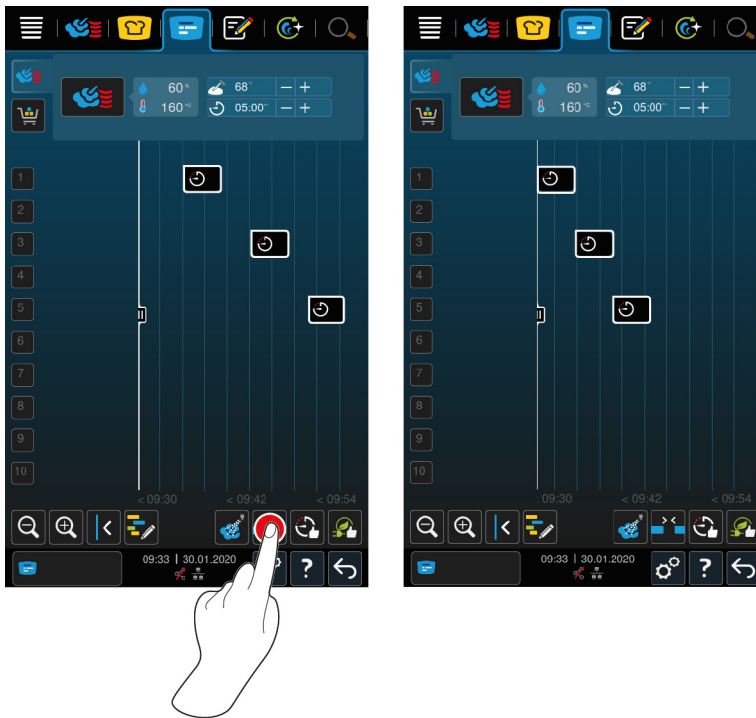

✓ You have created and placed tickets.

1. Press the button 

> You will be asked if you really want to close the planning gaps. **NOTICE! The action cannot be reversed.**

2. Confirm the question with: **OK**

>> The time gaps between the tickets are closed. The positioning of the tickets with regard to one another are maintained. The positioning of the tickets can be moved on the time axis.

10.4.4 Time optimisation

You can have tickets that you have already placed in iProductionManager automatically optimised by your iCombi Pro, in such a way that the dishes are cooked in an optimal sequence and time gaps are closed. The chronological order and the placement on the shelf levels is retained.

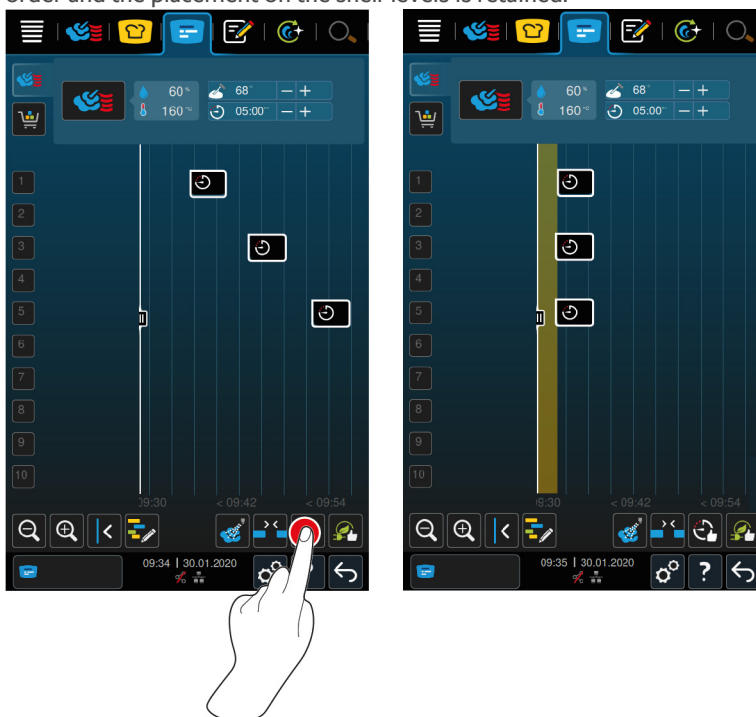

✓ You have created and placed tickets.

1. Press the button 

> You will be asked whether time gaps should really be closed. **NOTICE! The action cannot be reversed.**

2. Confirm the question with: **OK**

>> Depending on the combination check [▶ 57], the tickets are newly placed.

10.4.5 Energy optimisation

You can have tickets that you have already placed in iProductionManager automatically optimised by your iCombi Pro, so that the dishes are optimally cooked in terms of energy. The device utilisation can therefore be optimised and energy can be saved. Please note that the chronology of tickets can change.

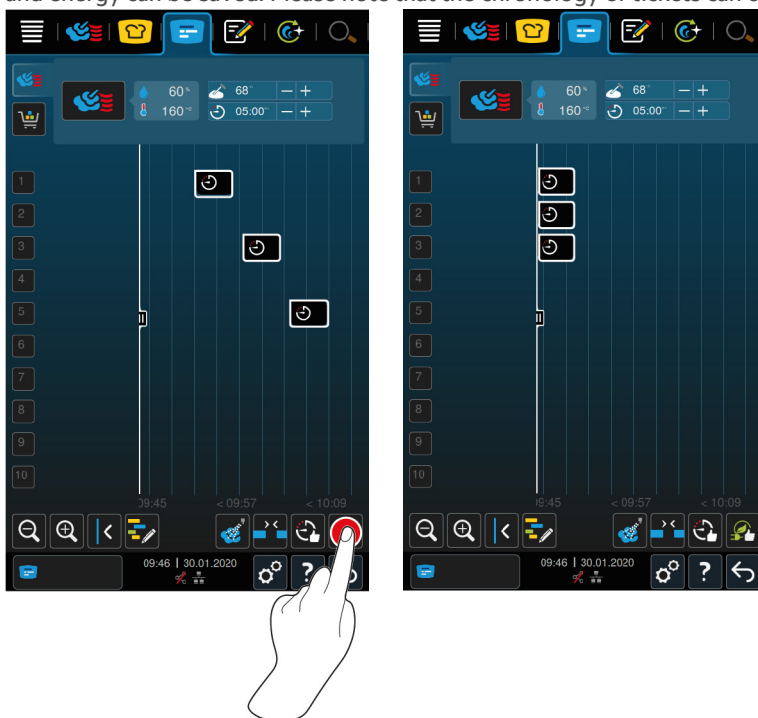

✓ You have created and placed tickets.

1. Press the button 

> You will be asked if the tickets should really be arranged in an energy optimised manner. **NOTICE! The action cannot be reversed.**

2. Confirm the question with: **OK**

>> Depending on the combination check [▶ 57], the tickets are newly placed.

10.5 Edit and delete tickets



Manual tickets

If you have placed a manual ticket, subsequently you can extend the core temperature or the cooking time. You cannot edit the set climate.

1. Press the ticket.
 - > The ticket settings are displayed.
2. If you want to increase or decrease the core temperature or extend or shorten the cooking time, press the buttons: **+** or **—**
3. To delete the ticket, press the button: 

Intelligent tickets and programmes

If you have placed an intelligent ticket or a programme, you cannot change the settings afterwards. You can only delete the ticket.

1. To delete the ticket, press the button: 

10.6 Target time cooking

You can plan meals in the iProductionManager, so that cooking of meals starts at the same time or meals are cooked at the same time. You can carry out this planning not only at the current time, but also in the future. To do this, place tickets in front of the positioning aid or behind it. When you start the iProductionManager, the positioning aid indicates the actual time. If you move the positioning aid to the right, you change the time axis in the future.

1. Press the button in the menu bar: 
2. Drag the positioning aid to the desired time on the time axis. If you move the positioning aid to the right edge of the display, the time axis will be deferred to the future.
3. Position the desired tickets to the right or left of the positioning aid.
 - > If you place a ticket to the left of the positioning aid, the end of the ticket is placed at this time. Your dishes will be cooked at the same time.
 - > If you place a ticket to the right of the positioning aid, the start of the ticket is placed at this time. Cooking begins at the same time.

10.7 Planning



With the planning function of the iProductionManager you only have to place tickets once, so that you can retrieve them at any time.



- It is not possible to save tickets that have already been processed as planning.
- The additional **inject steam** function is not available when planning.

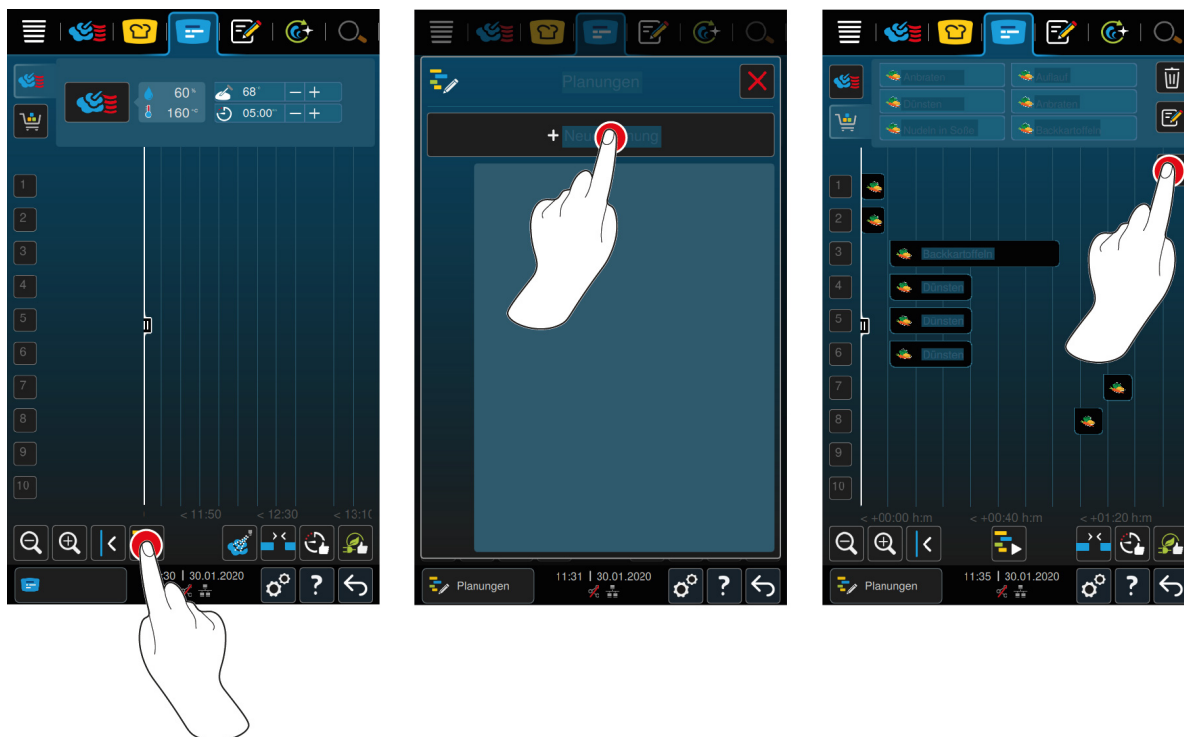

10.7.1 Create planning



1. Press the button in the menu bar: 
2. Press the button 
3. Press the button **+New planning**
 - > The positioning aid slides on the left edge of the display. The scaling of the time axis changes from the current time in the description to minutes. You can now place tickets, regardless of the time.
4. Position the desired tickets. You can place up to 30 tickets.

The following functions are available for planning optimisation:

- Close planning gaps [[▶ 57](#)]
- Time optimisation [[▶ 58](#)]
- Energy optimisation [[▶ 59](#)]

1. To start planning without saving, press the button: 
2. To save the planning, press the button: 

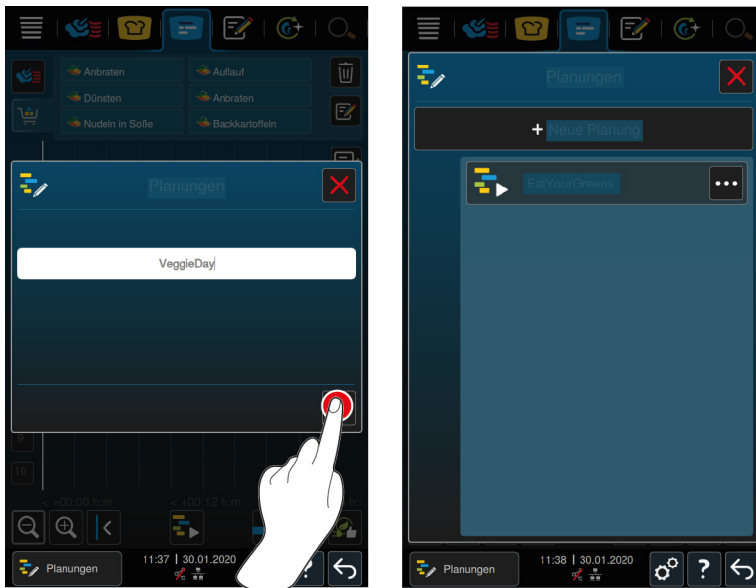

3. Assign a name.
 4. To confirm the action, press the button: ✓
- >> The planning is displayed in the planning list.

10.7.2 Start planning

- ✓ You have created a planning [▶ 61].
 - ✓ The iProductionManager is not currently processing any tickets. When tickets are processed, a message appears, informing you that all tickets must be cancelled before planning starts.
1. Press the button 
 2. Press the desired planning.
- >> The planning starts immediately. The tickets are placed on the racks according to the planning. The tickets on the ticket board are replaced by the tickets included in the planning.

11 Programming mode



In the programming mode, you can create, save and manage your own manual programmes [▶ 63], intelligent cooking paths [▶ 65] and shopping carts [▶ 66]. All the manual modes [▶ 43], intelligent cooking processes [▶ 27] and preset shopping carts are available for this.

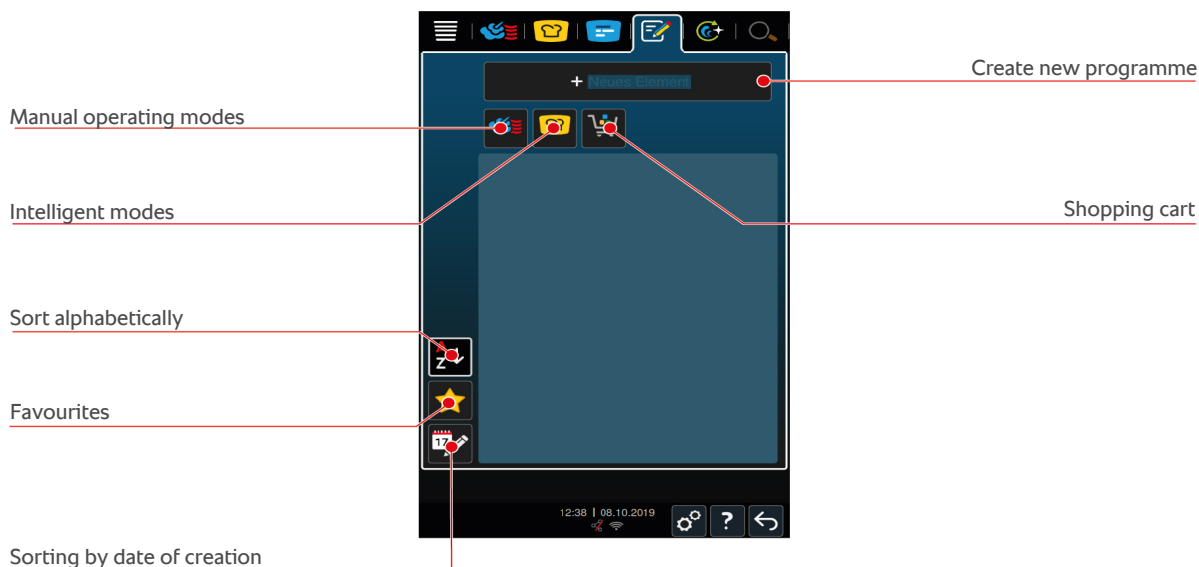

11.1 Create manual programme

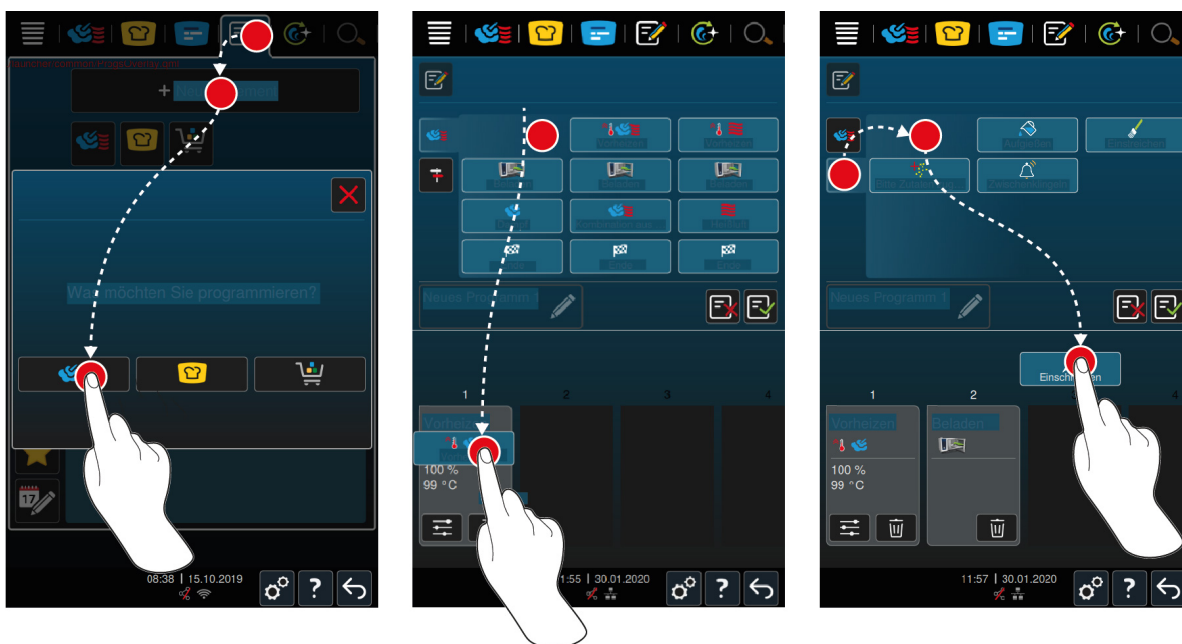

1. Press the button in the menu bar:
2. Press the button + **New element**
3. Press the button
- > An overview of the available cooking steps is displayed.
4. Select the desired cooking steps and drag them into the lower area. **NOTICE! You can only combine cooking steps that are one below the other. If you combine cooking steps with each other that are not one below the other, the programme cannot be saved.**
5. To add prompts to the programme, press the key:

- > An overview of the available prompts is displayed.
- 6. Select the prompts you want and drag them to the lower area.

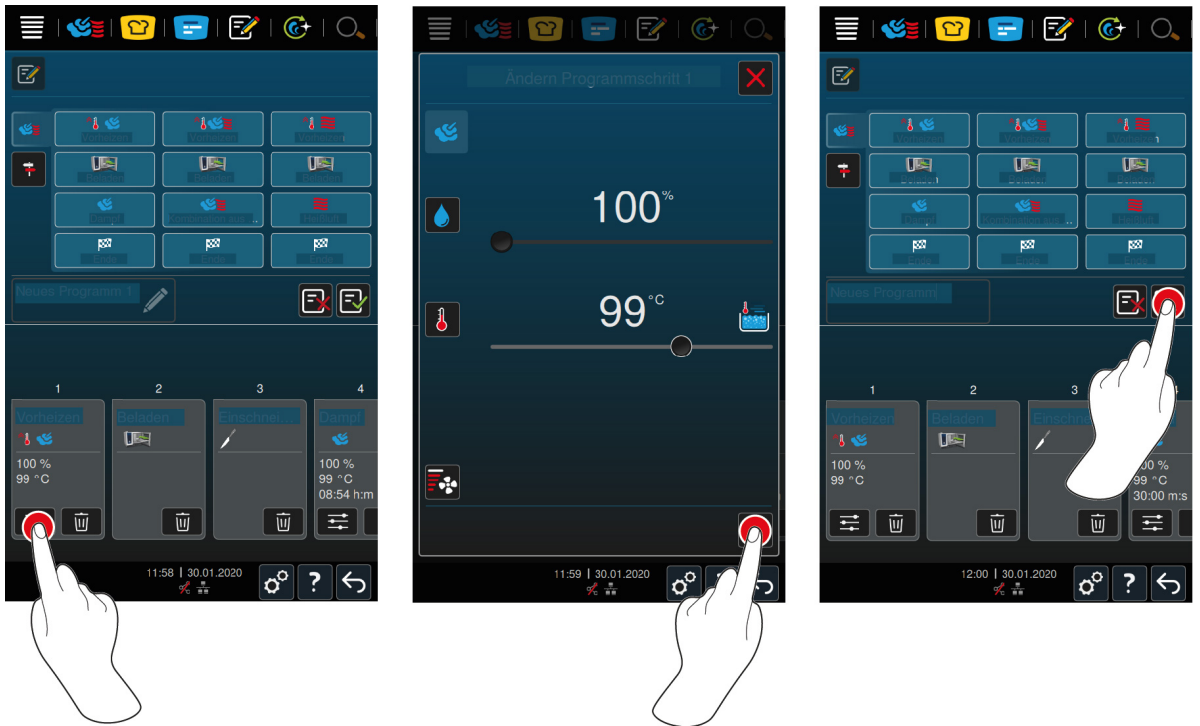

- 7. To edit a cooking step, press the button:
- > Depending on the selected mode, the adjustable cooking parameters and additional functions will be displayed.



Cooking step	Cooking parameters	Additional functions
Preheat	<ul style="list-style-type: none"> ▪ Cabinet temperature 	<ul style="list-style-type: none"> ▪ Air speed
Steam	<ul style="list-style-type: none"> ▪ Cabinet temperature 	<ul style="list-style-type: none"> ▪ Delta-T cooking ▪ Air speed
Combination of steam and hot air	<ul style="list-style-type: none"> ▪ Cooking cabinet humidity ▪ Cabinet temperature ▪ Cooking time ▪ Core temperature 	<ul style="list-style-type: none"> ▪ Delta-T cooking ▪ Air speed ▪ Humidification
Convection	<ul style="list-style-type: none"> ▪ Cooking cabinet humidity ▪ Cabinet temperature ▪ Cooking time ▪ Core temperature 	<ul style="list-style-type: none"> ▪ Delta-T cooking ▪ Air speed ▪ Humidification

1. Adjust the cooking step as required.
 2. To save your changes, press the button:
 3. To give the cooking process a name, press the button:
 4. Assign the name.
 5. To save the cooking process, press the button:
- >> The programme will be checked. When all cooking parameters have been set fully and placed in a logical order, the programme is saved and displayed in the programme list.
 - >> If the programme contains an error, the corresponding point will be marked. Resolve the error before saving the programme.

11.2 Program intelligent cooking process

If you program an intelligent cooking process, you can only adjust the cooking parameters to your requirements. You cannot change the order of the individual cooking steps.





1. Press the button in the menu bar: 
2. Press the button + **New element**
3. Press the button 
 - > You will be asked what you want to program.
4. Select one of the following options:
 - Cooking mode
 - Mode and cooking method
 - Cooking methods

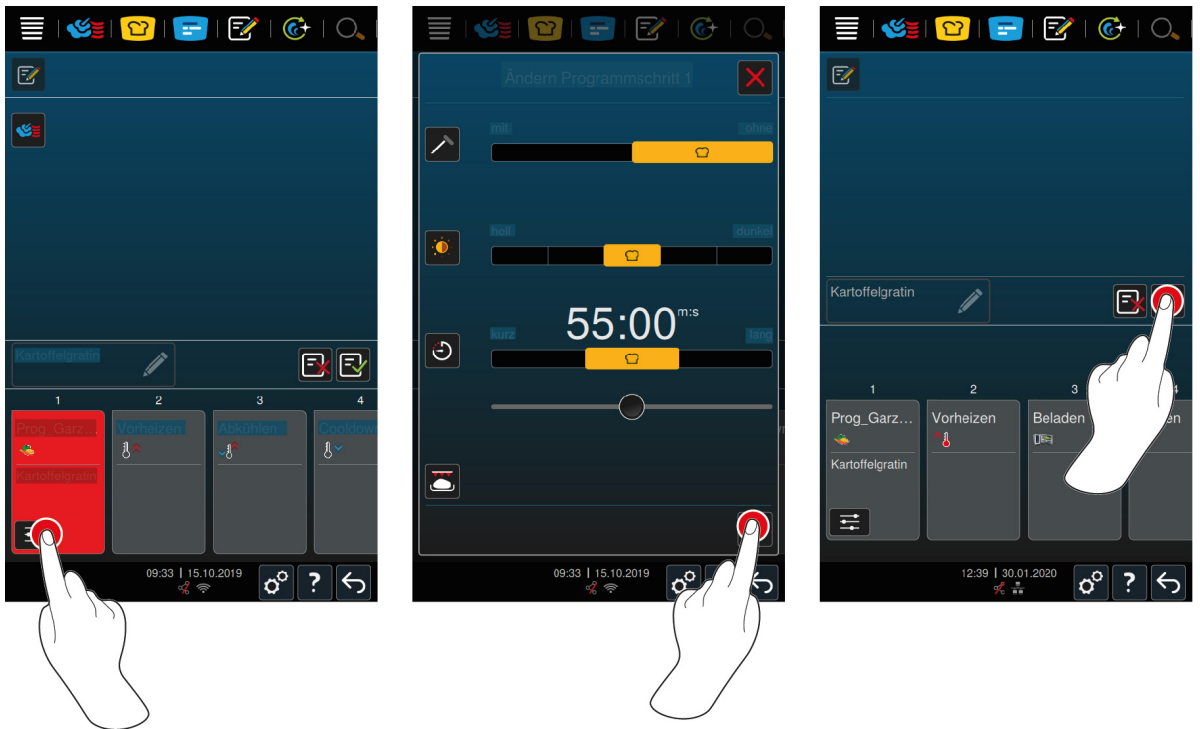

Once you have selected these, the corresponding intelligent cooking processes will be displayed.

1. Select the desired intelligent cooking process.
 - > The individual steps will be displayed. You can adjust the cooking parameters as required. The first cooking step is marked in red for that purpose.



2. Press the button 
 - > Depending on the selected cooking process, the adjustable cooking parameters and additional functions will be displayed. The standard settings of the cooking process are marked with the following symbol: 
3. Adjust the cooking parameters as required.
4. To save your changes, press the button: 

 - > The individual cooking steps will be displayed again.



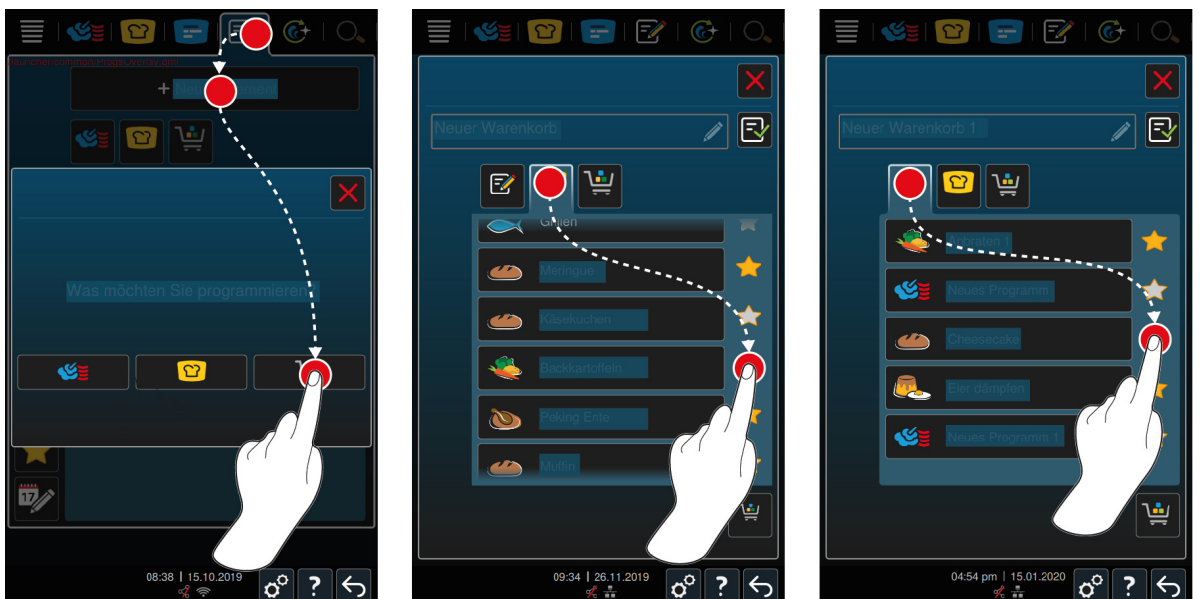

5. To give the cooking process a name, press the button: 
6. Assign a name.
7. To save the cooking process, press the button: 

 - >> The cooking path is shown in the programme list.





11.3 Programme the shopping cart

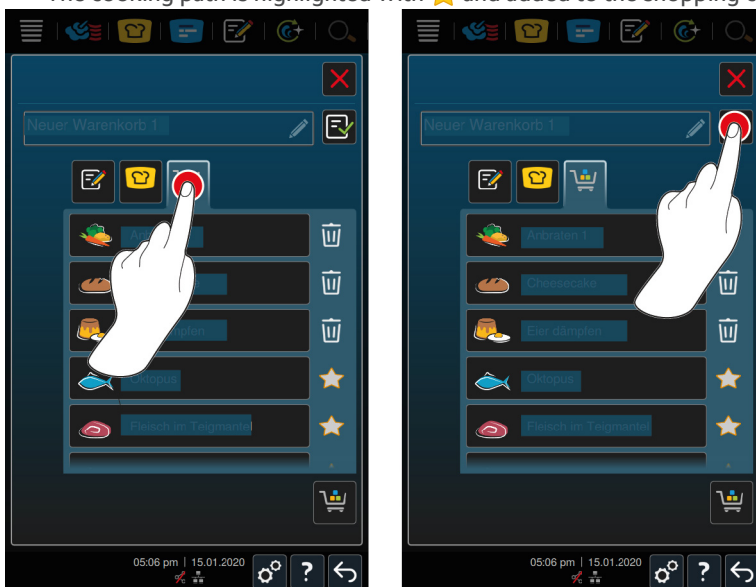

1. Press the button in the menu bar: 

2. Press the button + **New element**
3. Press the button 
4. To add intelligent cooking paths to the shopping cart, press the button: 
 - > All intelligent cooking paths are displayed.
5. Scroll through the list and press the desired cooking path.
 - > The cooking path is highlighted with  and added to the shopping cart.
6. To add programmes that are already saved to the shopping cart, press the button: 
 - > All programmes are displayed.
7. Scroll through the list and press the desired programme.
 - > The cooking path is highlighted with  and added to the shopping cart.





8. To check the shopping cart, press the button: 
 - > All chosen intelligent cooking paths and programmes are displayed.
 9. To delete an item from the shopping cart, press the button: 
 10. To give the shopping cart a name, press the button: 
 11. Assign a name.
 12. To save the shopping cart, press the button: 
- >> The shopping cart is displayed in the programme list.

11.4 Edit and delete programmes

✓ You have programmed manual programme [▶ 63], intelligent cooking paths [▶ 65] or shopping carts [▶ 66].

1. To edit a programme, press the button: ...

You can choose from the following editing options:

- Edit item 
- Duplicate item 
- Delete item 

11.5 Start programmes and shopping carts

Manual programmes

1. To start a manual programme, press the desired programme.

- > The programme immediately starts up. All cooking steps are displayed.
- 2. To send a manual programme to the iProductionManager, press the button: ...
- 3. Press the button 
 - > The manual programme is displayed in the ticket board. You can now place the ticket as normal [▶ 56].

Intelligent cooking processes

- 1. To start an intelligent cooking path, press the desired programme.
 - > The programme immediately starts up. All cooking steps are displayed.
- 2. To send an intelligent cooking path to the iProductionManager, press the button: ...
- 3. Press the button 
 - > The intelligent programme is displayed in the ticket board. You can now place the ticket as normal [▶ 56].

Shopping carts

- 1. To transfer a shopping cart to the iProductionManager, press the desired shopping cart.
 - > All elements of the shopping cart are displayed in the ticket board. You can now place the ticket as normal [▶ 56].

12 Switch between operating modes

With the iCombi Pro you can easily switch between the operating modes manual cooking, iCookingSuite and iProductionManager and at any time. This means that you have the optimal mix of automatic, labour-saving cooking intelligence and individually desired control options.

- Convert a ticket in the iProductionManager to a manual operating mode.
- Convert an intelligent cooking path of the iCookingSuite into an intelligent ticket in the iProductionManager.
- Convert an intelligent cooking path of the iCookingSuite into a manual operating mode.

Convert a ticket into a manual operating mode

- ✓ You have placed a ticket [▶ 56]. The cooking process is running.
- 1. Press the button in the menu bar: 
 - > A message appears informing you that a cooking process is already in progress.
- 2. **NOTICE! The action cannot be reversed.** Press the button **Change current process**
- >> The cooking parameters of the ticket are accepted and displayed in the manual operating mode.

Convert an intelligent cooking path into an intelligent ticket

- ✓ You have started an intelligent cooking path [▶ 36]. The cooking process is running.
- 1. Press the button in the menu bar: 
 - > A message appears informing you that a cooking process is already in progress.
- 2. **NOTICE! The action cannot be reversed.** Press the button **Change current process**
- >> The intelligent cooking path is sent to the iProductionManager and displayed on a shelf level.

Convert an intelligent cooking path into a manual operating mode

- ✓ You have started an intelligent cooking path [▶ 36]. The cooking process is running.
- 1. Press the button in the menu bar: 
 - > A message appears informing you that a cooking process is already in progress.
- 2. **NOTICE! The action cannot be reversed.** Press the button **Change current process**
- >> The cooking parameters of the intelligent cooking path are adopted and displayed in the manual operating mode.

13 Settings



You can permanently change the factory settings on your unit to suit your requirements.

1. Press the button 

> The overview of all possible settings is shown:

- Favourite [▶ 70]
- Display [▶ 70]
- Light [▶ 71]
- Sound [▶ 72]
- cooking system [▶ 73]
- Cooking [▶ 74]
- Cleaning [▶ 76]
- Data management [▶ 76]
- Network settings [▶ 78]
- MyEnergy
- Messenger
- User profile [▶ 79]
- Service [▶ 79]
- ConnectedCooking [▶ 79]

Change settings by scrolling through the list and pressing on the desired category. A selection of setting options is assigned to each category, which can be changed using simple gestures [▶ 17] or the central dial [▶ 17].

13.1 Favourites

All settings that you have marked as favourites are displayed in favourites.

1. Choose a setting.

2. Press the button 

>> The setting is saved as a favourite.

13.2 Display

1. Press the button 

2. Press the button  **Display**

You can adjust the following settings:

- Language [▶ 70]
- Date and time [▶ 70]
- Temperature format [▶ 71]
- Program view [▶ 71]

13.2.1 Language

Here you can change the language of the user interface.

1. Press the button  **Language**

2. Choose the desired language.

>> The language of the user interface is changed immediately.

13.2.2 Date and time

Here you can change the following settings:

- **Date** 

- **Time**
- **Toggle 24h/12h**

Please note that you can also have the time automatically synchronised with ConnectedCooking.

Date

1. Press the button **Date**
 - > A calendar is displayed.
2. Select the desired date.
- >> The date is automatically adopted.

Time

1. Press the button **Time**
 - > The time is displayed.
2. Press the time.
3. Set the desired time.
- >> The time is automatically adopted.

Toggle 24h/12h

1. Select **12** to set the 12-hour format and **24** to set the 24-hour format.

13.2.3 Temperature format

Here you can set whether the temperature should be displayed in °C or °F.

13.2.4 Programme view

Here you can set if intelligent cooking paths should be displayed in the iCookingSuite and in programming mode in one, two or three columns.

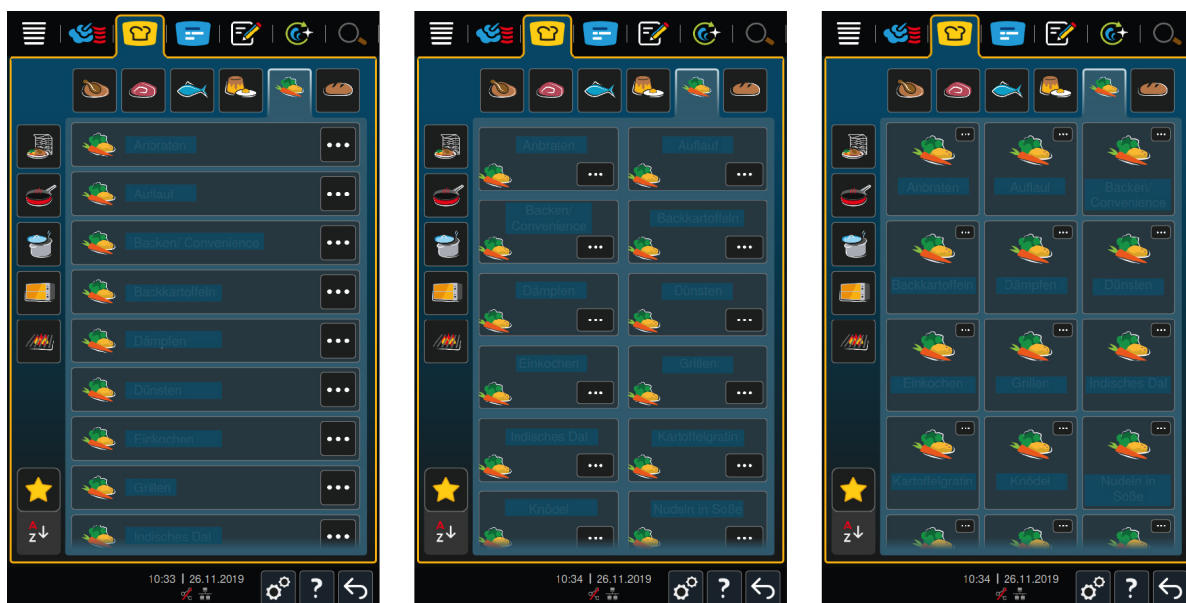

1. Press the button **Programme view**
2. Select **one column**, **two columns** or **three columns**.
- >> The selection is immediately adopted.

13.3 Light

1. Press the button



2. Press the button  **Light**

13.3.1 Display brightness

Here you can adjust the display brightness on a scale from 0 - 100%.

1. Press the button  **Display brightness**
 2. Select the desired value on the scale.
- >> The display brightness is immediately adopted.

13.4 Sound

1. Press the button 
2. Press the button  **Sound**

You can adjust the following settings:

- Master volume [▶ 72]
- Loading/calls for action [▶ 72]
- Programme step end [▶ 72]
- End of cooking time [▶ 73]
- Process interruption/error found [▶ 73]



13.4.1 Master volume

Here you can set the master volume of the unit on a scale of 0 - 100%.

1. Press the button  **Master volume**
 2. Select the desired value on the scale.
- >> The master volume is immediately adjusted.



13.4.2 Loading/calls for action

Here you can set which sound or melody you would like to sound when you want to either load the unit or ask it to perform an action. You can choose from 37 options.

1. Press the button 
 2. Press on the desired sound.
 - > The sound will play.
 3. If you want to switch off the sound, press the button: **OUT**
 4. To apply the setting, press the following button on the icon bar: 
- >> You will return to the overview. Your setting will be displayed.



13.4.3 Program step end

Here you can set which sound or melody you would like to sound when a programme step is completed. You can choose from 37 options.

1. Press the button 
 2. Press on the desired sound.
 - > The sound will play.
 3. If you want to switch off the sound, press the button: **OUT**
 4. To apply the setting, press the following button on the icon bar: 
- >> You will return to the overview. Your setting will be displayed.



13.4.4 End of cooking time

Here you can set which sound or melody you would like to sound when the cooking time has passed. You can choose from 37 options.

1. Press the button 
 2. Press on the desired sound.
 - > The sound will play.
 3. If you want to switch off the sound, press the button: **OUT**
 4. To apply the setting, press the following button on the icon bar: 
- >> You will return to the overview. Your setting will be displayed.

13.4.5 Process interruption/error found

Here you can set which sound or melody you would like to sound when an error is detected. You can choose from 37 options.

1. Press the button 
 2. Press on the desired sound.
 - > The sound will play.
 3. If you want to switch off the sound, press the button: **OUT**
 4. To apply the setting, press the following button on the icon bar: 
- >> You will return to the overview. Your setting will be displayed.

13.5 cooking system

1. Press the button 
2. Press the button  **Cooking system**

13.5.1 Information on unit model

Here you can see which model your unit belongs to and which software version is installed.

13.5.2 Demo mode

Here you can switch your unit to demo mode. This function is useful if you want to present the functionalities of your unit without cooking in it.

1. To activate the function, press the button:  **ON**

13.5.3 Power Steam

Here you can set that a constant, uninterrupted fresh steam supply is guaranteed in the Steam [▶ 45] operating mode for particularly demanding products.

CAUTION

Working with the Power Steam function will produce hot steam, including when you open the cooking cabinet door

You could scald yourself on the hot steam when opening the cooking cabinet door.

1. Carefully open the cooking cabinet door when working with the Power Steam function.

1. To activate the function, press the button:  **ON**

>> In the **Steam** operating mode, the boiling temperature is replaced by the symbol: 

13.5.4 Control nozzle





Here you can set if the control nozzle of the unit should condense excess steam or not. This function is activated by default and must be deactivated by you. This is particularly useful when the performance of your exhaust air system is sufficient, because you can save water by deactivating the control nozzle.

1. To deactivate the function, press the button:  **OFF**



13.5.5 Remote control

With Combi-Duos, this function enables you to transfer the screen of the lower unit to the screen of the upper unit, so that you can conveniently operate the lower unit from the display of the upper unit.

Please note: Configure the settings on both units of the Combi-Duo.

- ✓ The units are connected to each other with a network cable.
1. Press the button  **Unit name**
 2. Enter a unique unit name and press the Enter key on the keyboard.
 - > Your entry is automatically accepted.
 3. Press the button  **Unit colour**
 4. Choose a colour on the display that can be used to identify the unit.
 - > Your entry is automatically accepted.
 5. To activate the function, press the button:  **Remote control ON**
 - > The following symbol appears in the footer: 
 6. To switch back and forth between the units, press the button: 
- >> The display is outlined with the set unit colour.

13.6 Cooking

1. Press the button 
2. Press the button  **Cooking**



13.6.1 Primary country cuisine

In the primary country cuisine, cultural eating habits are translated into intelligent cooking paths. The cooking parameters of these intelligent cooking paths reflect these eating habits and dishes are prepared as expected by the visitors in the respective country. This means that not only can you master your local cuisine, but all the cuisines of the world. This setting is independent of the language selection.

1. Press the button  **Primary country cuisine**
2. Scroll through the list and select the desired primary country cuisine.
 - >> The country cuisine is immediately adopted. In the iCookingSuite, the intelligent cooking paths that correspond to the national cuisine are displayed. The cooking parameters of the intelligent cooking paths are adapted to the cultural eating habits.

13.6.2 Secondary country cuisine

You can add an additional country cuisine to the primary country cuisine. This allows you to prepare typical dishes from 2 countries at the same time. This is an advantage, for example, if your restaurant wants to offer a special weekly menu with another country cuisine.

1. Press the button  **Secondary country cuisine**
2. Scroll through the list and select the desired secondary country cuisine.
 - >> The country cuisine is immediately adopted. In the iCookingSuite, the additional intelligent cooking paths of the secondary country cuisine are displayed and marked with . The settings of the cooking parameters are still influenced by the primary country cuisine [▶ 74].

13.6.3 À la carte plate weight

Before you start the finishing, set how heavy an empty plate is. With the help of this information, your iCombi Prowill adjust the cooking steps, so that you achieve an ideal finishing result and no moisture condenses on the plates. Click here for more information: Adjust plate weight à la carte [► 51]

13.6.4 Banquet plate weight

Before you start the finishing, set how heavy an empty plate is. With the help of this information, your iCombi Prowill adjust the cooking steps, so that you achieve an ideal finishing result and no moisture condenses on the plates. Click here for more information: Adjust banquet plate weight [► 51]

13.6.5 Number of racks



Here you can set how many racks you want to use in the iProductionManager.

1. Press the button  **Number of racks**
 2. Select the desired value from 0-10 on the scale.
- >> The setting is immediately adopted.

13.6.6 Order of racks

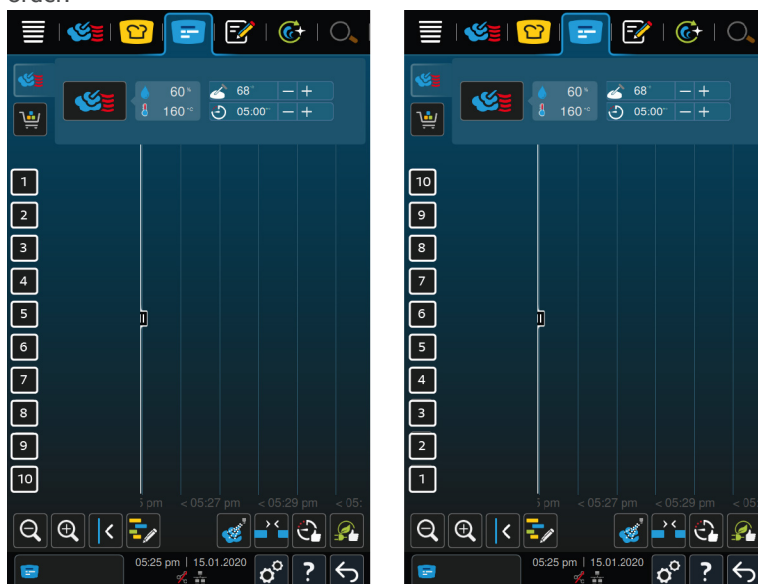
Here you can set if the order of racks in the iProductionManager should be displayed in ascending or descending order.



1. To display the racks in ascending order, press the button:  **123**
 2. To display the racks in descending order, press the button:  **321**
- >> The setting is immediately adopted.

13.6.7 Climate retention time

Here you can set how long the climate in the cooking space should be maintained, if you do not prepare dishes with the iProductionManager.

1. Press the button  **Climate retention time**
 2. Select the desired value on the scale.
- >> The retention time is immediately adjusted.

13.6.8 iProductionManager 3D

Here you can set that you want to load onto the racks with two metal sheets in the iProductionManager. Each metal sheet is monitored separately. Please note that no more than 12 racks can be displayed.

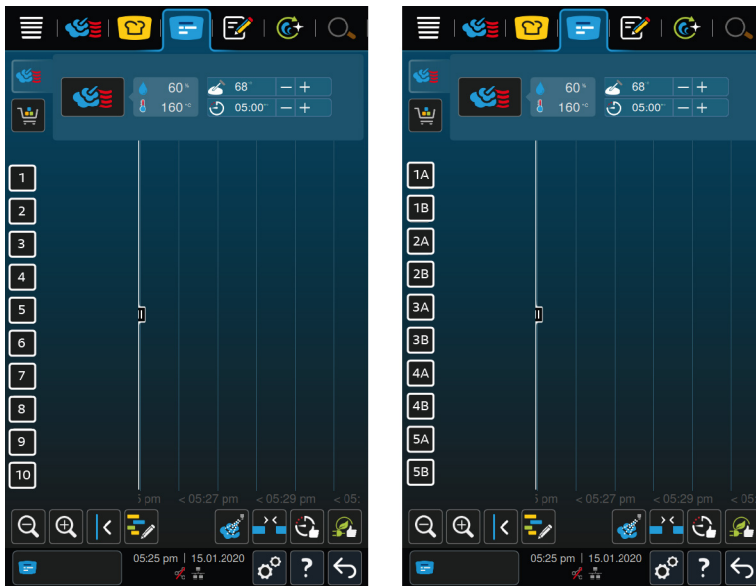

1. To activate the function, press the button: **ON**
>> The setting is immediately adopted.

13.7 Cleaning

1. Press the button
2. Press the button **Cleaning**

13.7.1 Forced cleaning

Here you can set how long you would like to pass before you receive a reminder to clean the unit. You cannot work with the unit again until the cleaning has been performed. This means that you can ensure that cleaning and hygiene regulations are observed when the unit is in shift operation. Click here for more information: [Forced cleaning \[► 90\]](#)

13.7.2 Cleaning plan

Here you can set on which days of the week you want the unit to perform a forced cleaning process. This means that you can ensure that cleaning and hygiene regulations are observed when the unit is in shift operation. Click here for more information: [Cleaning plan \[► 90\]](#)

13.8 Data management

Please note that the **data management** functions are only available if you connect a USB flash drive to the unit.

1. Press the button
2. Press the button **Data management**

You can adjust the following settings:

- Export HACCP data [► 76]
- Export error statistics log [► 78]
- Export and import programs [► 77]
- Export and import profiles [► 77]
- Export and import basic unit settings [► 78]

13.8.1 Export HACCP data

Here you can export all HACCP data recorded by the unit to a USB stick. You can also have the HACCP data automatically transferred to ConnectedCooking.

- ✓ You have connected a USB flash drive with the unit.

1. Press the button  **Copy HACCP log to a USB stick**

>> The HACCP data is saved on the USB stick.

13.8.2 Export and import programmes

Here you can export and import all the programs you have created.

Export programs

- ✓ You have created programs in the programming mode.
- ✓ You have connected a USB flash drive to the unit.

1. Press the button  **Export programs**

>> The saved programs are saved on the USB flash drive.

Import programs

1. Connect a USB flash drive containing the exported programs to the unit.
2. Press the button  **Import programs**

>> The saved programs are imported and displayed in programming mode.

13.8.3 Delete all programs

Here you can delete all programs you have created.

1. Press the button **Delete all programs**

> You will be asked if you really want to delete the programs.

2. To confirm the action, press the button: 

>> A message will confirm that all programs have been deleted.

13.8.4 Export and import profiles

Export profiles

- ✓ You have created a profiles.
- ✓ You have connected a USB flash drive to the unit.

1. Press the button  **Export profiles**

>> The saved programs are saved on the USB flash drive.

Import profiles

1. Connect a USB flash drive containing the exported programs to the unit.
2. Press the button  **Import profiles**

>> The saved profiles are imported and are displayed in the user management area.

13.8.5 Delete all own profiles

Here you can delete all profiles you have created. The preset profiles will not be deleted.

1. Press the button **Delete all own profiles**

> You will be asked if you really want to delete the profiles.

2. To confirm the action, press the button: 

>> A message will confirm that all own profiles have been deleted.

13.8.6 Export and import images

Here you can import and export all images you have created.

Import images

1. Connect a USB flash drive containing the images to the unit.
 2. Press the button  **Import images**
- >> The saved images will be imported.

Export images

- ✓ You have imported images.
 - ✓ You have connected a USB flash drive to the unit.
1. Press the button  **Export images**
- >> The saved images will be saved onto the USB flash drive.

13.8.7 Delete all own images

Here you can delete all images you have imported.

1. Press the button **Delete all own images**
 - > You will be asked if you really want to delete the programs.
 2. To confirm the action, press the button: 
- >> A message will confirm that all own images have been deleted.

13.8.8 Export and import basic unit settings**Export basic unit settings**

- ✓ You have connected a USB flash drive with the unit.
1. Press the button  **Export basic unit settings**
- >> The basic unit settings are saved on the USB stick.

Import basic unit settings

1. Connect a USB stick on which the already exported basic unit settings are connected to the unit.
 2. Press the button  **Import basic unit settings**
- >> The basic unit settings are imported.

13.8.9 Delete all user data**13.8.10 Export developer log****13.8.11 Export error statistics log**

Here you can export the error statistics log to a USB stick.

- ✓ You have connected a USB flash drive with the unit.
1. Press the button  **Copy the error statistics log to a USB stick**
- >> The error statistics log is saved on the USB stick.



13.9 Network settings

1. Press the button 
2. Press the button  **Network settings**

You can find out how to connect your unit to a WiFi network here: Establish a wireless connection [▶ 83]



You can find out how to connect your unit to the network here: Establish network connection [▶ 84]

13.10 User administration





1. Press the button 
2. Press the button  **User administration**

How to create, change and transfer profiles to other units can be found here: Profile and rights management [▶ 80]

13.11 Service

1. Press the button 
2. Press the button  **Service**

The following information is available:

- Information on the unit model 
- ChefLine [▶ 95] 
- Hotline - Service [▶ 95] 
- Service levels 
 - This function is only available to RATIONAL service partners.
- Software update info [▶ 79] 
- Installed software version [▶ 79]

13.11.1 Software update info

Here you can see which software version is installed on your unit. If you have connected your unit to ConnectedCooking and activated the **Download software updates automatically** function, software updates will be made available to you automatically. Click here for more information: Carry out software updates automatically [▶ 86] If a software update is available, the current software version is displayed and the **Start installation** button is active.

1. Press the button **Start installation**

>> The software update is carried out and the unit is restarted.

13.11.2 Installed software version

Here you will find all information about the installed software version and installed help packages.

13.12 ConnectedCooking

1. Press the button 
2. Press the button  **ConnectedCooking**





You can find out how to connect your unit to ConnectedCooking and which functions are available here: ConnectedCooking [▶ 85]

14 Kitchen management









14.1 Profile and rights management

You can group users into profiles and assign access rights to these profiles. By default, your unit is assigned a profile that cannot be deleted. You can add up to 10 more profiles.

14.1.1 Create new profile

1. Press the button 
2. Press the button  **User profile**
3. Press the button **Add new profile**
4. If you want to derive a profile from an existing profile, press the button: **from an existing profile**
5. If you want to derive a profile from a profile template, press the button: **from a profile template**
 - > A message saying that the new profile has been successfully created will be displayed.
6. Press  in the icon bar to return to the overview of user profiles.
7. Press the button  **Edit profile**
8. Press the button  **New profile**









Change profile settings

1. Press the button  **Profile settings**
2. To give the profile a name, press the button:  **Change profile name**
3. Enter a unique profile name and press the Enter key on the keyboard.
 - > You will return to the profile overview.
4. To assign a password to the profile, press the button:  **Change profile password**
5. Enter a password and press the Enter key on the keyboard. Document the password and protect it against access from unauthorised third parties. If you forget the password, you can no longer access the settings. In this case, please contact your RATIONAL service partner.
 - > You will return to the profile overview.
6. To assign a language to the profile of the unit interface, press the button:  **Change language**
7. Scroll through the list and select the language you want.
 - > You will return to the profile overview.
8. To assign the profile, if it should be the main user or a profile with restricted rights, press the button:  **Change profile type**
9. Select  **Main user** if the user profile should have all rights to be able to edit profiles. If you select this profile type, all users will have full access to the unit
10. Select  **Restricted user** if you want the user profile to have restricted rights. If you select this profile type, you can hide all elements of the user interface except the favourites.
 - > You will return to the profile overview.
11. To assign a primary country cuisine to the profile, press the button:  **Change primary country cuisine**
12. Scroll through the list and select the desired primary country cuisine.
 - > You will return to the profile overview.
13. To assign a secondary country cuisine to the profile, press the button:  **Change secondary country cuisine**
14. Scroll through the list and select the desired secondary country cuisine.
 - > You will return to the profile overview.
15. If you want to hide all the elements of the user interface except the favourites, press the following button behind **Hide all elements except favourites: ON**



16. Press  in the icon bar to return to the overview of user profiles.

Customise the menu bar





Define which functions and intelligent assistants should be displayed in the menu bar.

1. Press the button  **Customise the menu bar**
2. If you want to hide a function or intelligent assistant, press the button behind the following elements:**OFF**
 - Home 
 - Manual operating modes 
 - iCookingSuite 
 - iProductionManager 
 - Programming mode 
 - iCareSystem 
 - Search assistant 
1. Press  in the icon bar to return to the overview of user profiles.



Cooking parameter rights

1. Press the button  **Cooking parameter rights**
2. To allow the user profile to change the cooking parameters during cooking, press the button:  **touchable**
3. To prevent the user profile from changing the cooking parameters during cooking, press the button:  **hidden**

iProductionManager

1. Press the button **Profile settings**
2. If you want to hide a function, press the button behind the following elements:**OFF**
 - Humidification 
 - Edit ticket board 
 - Planning 
 - Optimisation functions
 - Manual ticket board 
1. Press  in the icon bar to return to the overview of user profiles.

14.1.2 Activate profile

- ✓ You have created a profile [▶ 80].
1. Press the button  **Activate profile**
 2. Select the desired profile.
 3. If you have assigned a password to the profile, enter the password.
 4. To confirm the action, press the button: 
- >> The profile is immediately activated.

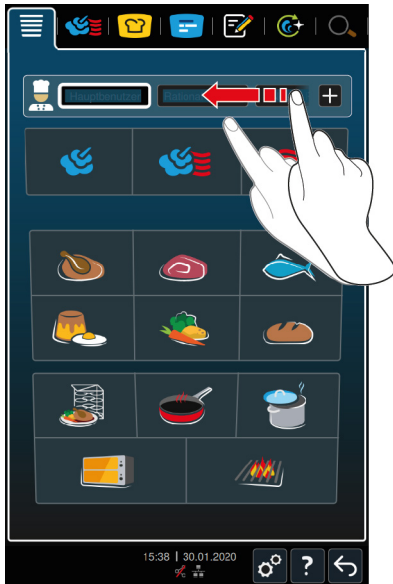







>> When you open the start screen, the activated profile is displayed. If several profiles are displayed, you can scroll through the list. To Create a new profile [▶ 80], press the button: +

14.1.3 Transfer profile to other units

You can transfer profiles that you have created on one unit to other units:

✓ You have connected a USB flash drive with the unit.



1. Press the button 
2. Press the button  **User profile**
3. Press the button  **Profile export**
 - > All created profiles are loaded onto the USB stick.
4. Connect the USB stick that contains the downloaded profiles to another unit.
5. Press the button 
6. Press the button  **User administration**
7. Press the button  **Profile import**

>> All profiles are loaded onto the unit and displayed after a short wait.

14.1.4 Delete profile

You can delete all profiles except the administrator profile that is assigned by default.

✓ You have created a profile [▶ 80].

1. Press the button  **Edit profile**
2. Select the desired profile.
3. Press the button  **Profile settings**
4. Press the button  **Delete profile**

>> The profile is deleted.

14.2 Hygiene management

14.2.1 Logged HACCP data

The following HACCP data is logged for each batch:

- Batch number
- Unit model

- Serial number
- Software version
- Date and time
- Cleaning programme
- Cabinet temperature
- Set core temperature
- Measured core temperature
- Time (hh:mm:ss)
- Temperature unit
- Energy optimising system connection
- 50% energy
- Name of cooking process
- Opening / closing the cooking cabinet door
- Change of mode
- Automatic cleaning



14.2.2 Exporting HACCP data

HACCP data will be stored in the unit for 40 days. During this time, you can download the data. Click here for more information: [Export HACCP data](#) [▶ 76]

14.2.3 Transfer HACCP data automatically to ConnectedCooking

If you have connected your unit with ConnectedCooking, you can set it so that the HACCP data is automatically transferred to ConnectedCooking once a cooking process is complete.

✓ Your unit is connected with ConnectedCooking [▶ 85].

1. Press the button 
2. Press the button  **ConnectedCooking**
3. Next to **Automatically transfer HACCP data**, press the button:  **ON**

>> HACCP data will now be automatically transferred when a cooking process is completed. You can view the data at connectedcooking.com or in the ConnectedCooking app.

14.3 Connected units to a network

When you network your units, you have the following options:

- Operate both units of a Combi-Duo installation on just one unit.
- Connecting units with ConnectedCooking.

If you want to network the units of a Combi-Duo installation, please contact your RATIONAL service partner.

14.3.1 Establishing a WiFi connection

1. Press the button 
2. Press the button  **Network**
3. To activate the function, press the button:  **ON**
4. Press the button  **WLAN**
 - > A list of all available WiFi networks is displayed.
5. Select the desired WiFi network.
 - > You will be asked to enter the password of the WiFi network.
6. To confirm the action, press the button: **OK**

>> If the connection has been successfully established, the following symbol appears in the footer: 

14.3.2 Connect network cable

Your unit is equipped with a network connection as standard. To connect your unit to the network and to protect the unit from water jets from all sides, use a network cable with the following properties:

- Network cable category 6
- Maximum plug length of 45 mm
- Plug diameter of 18.5 mm
- Cable diameter of 5.5 – 7.5 mm

⚠ CAUTION

The functional parts around the network connection can heat up to over 60 °C

You can burn yourself if you connect a network cable to a unit that is currently in use or has just been in use.

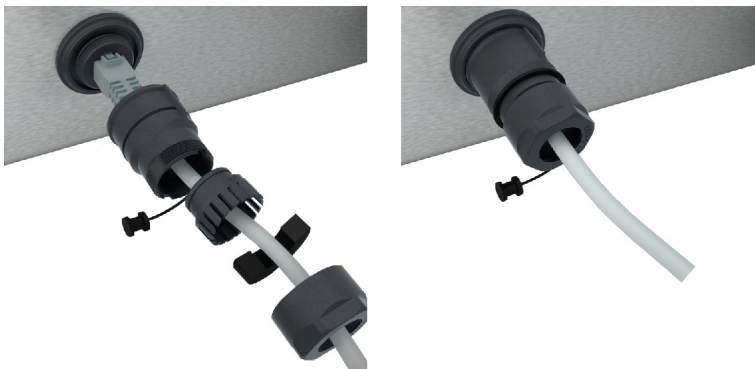

1. Let the unit cool down before connecting the network cable.



1. Unscrew the protective cover.
2. Thread the individual parts of the protective cover onto the network cable.
3. Plug the network cable into the network connection.
4. Screw the protective cover back on.

14.3.3 Establish network connection

✓ You have all the data for the network connection.

1. Press the button 
2. Press the button  **Network settings**
3. Press the button  **LAN**
4. Press the button **IP IP network**
5. Enter the IP address.
6. Press the button **IP IP Gateway**
7. Enter the IP address of the IP Gateway.
8. Press the button **IP IP Netmask**
9. Enter the IP netmask.
10. If you would like a server to assign the network configuration to customers, activate DHCP. Press the button **IP ON**
 - > Now the IP address, Gateway and DNS are automatically configured.
11. Press the button **IP DNS 1 (preferred)**
12. Enter the address of the DNS server.

14.4 ConnectedCooking

ConnectedCooking is the most modern network solution by RATIONAL. Whether you use one or more RATIONAL units, ConnectedCooking offers you completely new and convenient application options. The only thing you need to do is connect your RATIONAL unit to a network and register at connectedcooking.com.

In ConnectedCooking you can see the online status, cleaning details, the operating statistics and if the HACCP requirements are being complied with at a glance. The following features are also available:

- **Push notifications**

Whether it's a load, ready or service notification, all information will be conveniently sent to you in real time, exactly where you want it.

- **Transferring and managing cooking programmes**

Transfer tried and tested cooking paths automatically to all units in your business.

- **Automatic software updates**

Software updates are always made available to you free of charge and automatically.

You will also find comprehensive recipe libraries, tips and tricks from our professionals and a variety of application videos at connectedcooking.com.

14.4.1 Connect unit with ConnectedCooking

When you connect your unit to ConnectedCooking, the following features are available:

- Transfer HACCP data automatically to ConnectedCooking [▶ 83]
- Automatically transferring service data to ConnectedCooking [▶ 95]

- ✓ You have established a network connection.
- ✓ You have registered at connectedcooking.com.

1. Press the button 
2. Press the button **ConnectedCooking**
3. Next to **ConnectedCooking active**, press the button: **ON**
 - > After a short wait, a nine-digit PIN and a QR code are displayed.

Registration without smartphone

1. Write down the PIN.
2. Log onto www.connectedcooking.com.
3. Select: **My units > Overview > + Add unit**
4. Enter the PIN.
 - > The unit is registered in ConnectedCooking.
 - > After a short wait, the following is displayed: **ConnectedCooking** ✓
 - > The symbol appears in the footer: 







Registration with smartphone

- ✓ You have installed an app on your smartphone that you can use to scan QR codes.
 - ✓ You have installed the ConnectedCooking app on your smartphone.
1. Scan the QR code.
 - > The unit is registered in ConnectedCooking.
 - > After a short wait, the following is displayed: **ConnectedCooking** ✓
 - > The symbol appears in the footer: 

14.5 Perform software update

Automatic software updates with ConnectedCooking

✓ Your unit is connected with ConnectedCooking.

1. Press the button 
2. Press the button  **ConnectedCooking**
3. To activate the **Download software updates automatically** function, press the button:  **ON**
4. Press the button 
5. Press the button  **Service**
6. Press the button  **Software update info**
7. Press the button **Start installation**

>> The software update is carried out and the unit is restarted.

Software update by USB stick

✓ You have connected a USB stick to the unit on which there is a software update.

✓ A message is displayed telling you that a software update has been detected.

1. Confirm the message that the software update should be carried out.

>> The software update is carried out and the unit is restarted.

15 Automatic cleaning - iCareSystem



The iCareSystem is the intelligent cleaning and descaling system in the iCombi Pro. It recognises how dirty the unit is and proposes the ideal cleaning program and the optimal quantity of care products.



15.1 General safety instructions

- For the automatic clean function, only use the Active Green cleaner tablets and care tabs recommended by the manufacturer.

This will prevent scalding and burns:

- Let the unit and all function parts cool down before you start the automatic clean.

This will prevent chemical burns:

- The care products can cause severe chemical burns on the skin and serious damage to the eyes. Wear tight-fitting protective glasses and chemical-safe protective gloves while cleaning the unit.
- Keep the cooking cabinet door closed during the automatic clean. Corrosive cleaning agents and hot steam may otherwise escape. If you open the cooking cabinet door during the automatic clean, a warning signal will sound.
- Do not leave the core probe hanging out of the unit during the automatic clean. The cooking cabinet door gasket could be damaged and corrosive cleaning agents may escape.
- Do not clean externally attachable core probes with the automatic clean function.
- Remove all care products and residues of care products before heating up the unit and cooking food in it.

If you come in contact with care products, proceed as follows:

- If you touch care products without chemical-safe protective gloves or other skin areas come in contact with Active Green cleaner tablets, rinse the skin area with running water for 10 minutes.

- If a care product gets into your eyes, rinse your eyes with running water for 15 minutes. Remove any contact lenses.
- If you swallow a care product, rinse out your mouth with water and immediately drink half a litre of water. Do not provoke vomiting.
- Call the emergency poison helpline or a doctor.

15.2 Cleaning modes

The 2 following cleaning modes are available for the **light**, **medium** and **fast** cleaning programmes:



Eco mode

If you select this cleaning mode, less care product and less water will be used to clean the unit when using the cleaning programmes [► 88]. The cleaning programmes will therefore run for longer than in the normal mode.



Normal mode

If you select this cleaning mode, more care product and more water will be used to clean the unit when using the cleaning programmes [► 88]. The cleaning programmes will therefore be shorter than in the Eco mode.

15.3 Cleaning programmes

The following cleaning programmes are available:

Programme	Mode	Description	Care product
light	Eco / Normal	Suitable for removing light dirt and scale resulting from use of the unit at up to 200 °C.	<ul style="list-style-type: none"> ▪ Active Green cleaner tablets
medium	Eco / Normal	Suitable for removing dirt and scale resulting from cooking processes including grilling or roasting.	<ul style="list-style-type: none"> ▪ Active Green cleaner tablets ▪ care tabs
heavy	Eco / Normal	Suitable for removing heavy dirt and scale resulting from cooking processes including grilling or roasting.	<ul style="list-style-type: none"> ▪ Active Green cleaner tablets ▪ care tabs
Quick clean	–	Suitable for removing light dirt.	<ul style="list-style-type: none"> ▪ Active Green cleaner tablets
Rinse without tabs	–	Suitable for removing water-soluble dirt.	–
Rinse	–	Suitable for removing calcium/chalky dirt resulting from cooking processes including baking or steaming.	<ul style="list-style-type: none"> ▪ Active Green cleaner tablets



TIP

If your unit is connected to a water softener, the recommended quantity of Active Green cleaner tablets can be reduced by up to 50 %.

15.4 Cleaning and care status

iCareSystem automatically detects the cleaning and care status of your unit.

Cleaning status

- If the display is green, the unit is clean.
- If the display is yellow, the unit is dirty. You can still continue cooking in the unit until you are asked to clean it.
- If the display is red, the unit is very dirty. Start a cleaning program immediately, at least before next being asked to clean the unit.

Care status

- If the care status is green, the steam generator is free of scale.
- If the display is yellow, the steam generator has some scale
- If the display is red, the steam generator has a lot of scale. Start a cleaning program immediately, at least before next being asked to clean the unit.

15.5 Start automatic clean

- ✓ The hinging racks are correctly placed in the cooking cabinet.
- ✓ The mobile oven rack is correctly placed in the cooking cabinet.
- ✓ If your unit is equipped with the optional integrated fat drain, take the fat drip tray out of the cooking cabinet and insert the plug into the drain pipe hole . You can set the unit so that you are prompted to close the integrated fat drain before starting an automatic clean. Click here for more information: [Integrated fat drain](#)

1. Press the button in the menu bar: 
 - > If the cooking cabinet temperature is above 50 °C, this message is displayed: **Cooking cabinet too hot**
2. Start the cool down function [▶ 44] to reduce the cooking cabinet temperature.
3. Select the desired cleaning programme [▶ 88].
4. Open the cabinet door.
5. Remove all containers, racks and trays from the cooking cabinet.



6. **⚠ WARNING! Danger of chemical burns! Wear tight-fitting protective glasses and chemical-safe protective gloves for reliable protection when handling Active Green cleaner tablets and care tabs.** Unpack the displayed number of Active Green cleaner tablets and place them in the indentation in the floor drain sieve.
7. Unpack the displayed number of care tab packages and place them in the care drawer.
8. Close the cooking cabinet door.
- >> The automatic clean starts when the door is closed.
- >> Once the automatic clean is completed, an acoustic signal will sound.

**TIPS**

- If foam forms in the cooking cabinet during the automatic clean although you used the recommended number of Active Green cleaner tablets, reduce the number of tabs in the next automatic clean. If foam still forms, contact your RATIONAL Service Partner.

15.6 Abort automatic clean

You can abort all automatic cleaning programmes, except for the fast clean, 30 seconds after you start them. After that, the automatic clean cannot be aborted.

- ✓ The message is displayed: **Remove grids / containers**
- 1. Press the button 

- > The message is displayed: **Remove cleaner tablets - manual rinse**
- 2. Open the cabinet door.
- 3. **⚠ WARNING! Danger of chemical burns! Wear tight-fitting protective glasses and chemical-safe protective gloves for reliable protection when handling Active Green cleaner tablets.** Remove the Active Green cleaner tablets from the cooking cabinet and dispose of them.
- 4. Close the cooking cabinet door.
- 5. Press the button
- 6. Rinse the cooking cabinet using the hand shower.
- 7. Close the cooking cabinet door.
- > The display will show when the unit can be used again. Once the time has elapsed, an acoustic signal will sound.
- > The message is displayed: **Abort successful - please check the cooking cabinet for cleaner residues**

**TIP**

If there is a power outage during the automatic clean, the automatic clean will be interrupted. When the power supply is restored, the automatic clean will continue.

15.7 Forced cleaning

If you have activated a forced cleaning process, you will be asked to clean the unit after a defined period of time. You cannot work with the unit again until the cleaning has been performed.

1. Press the button
 2. Press the button **Cleaning**
 3. Press the button **Forced cleaning**
 4. To activate the forced cleaning process, press the button: **ON**
 5. To set how long you would like to pass before you receive a reminder to clean the unit, press the button: **Time until cleaning reminder** Please note that you should not indicate the operating time here, but rather the time that you want to pass until the reminder.
 6. Select a value from 1 to 24 hours on the scale.
 7. To set the number of hours the cleaning can be pushed back until the reminder, press the button: **Forced cleaning delay time**
 8. Select a value from 1 to 24 hours on the scale.
- >> The footer shows how many operating hours remain until cleaning needs to be carried out.

15.8 Cleaning plan

With the help of a cleaning plan, you can determine on which days of the week a forced cleaning process [▶ 90] must be carried out.

1. Press the button
 2. Press the button **Cleaning**
 3. Press the button **Cleaning time schedule**
 4. If you would like to be able to postpone the cleaning by a defined period, press the button: **Cleaning mode**
 5. Press the button **Warning**
 6. To set the unit to clean itself as soon as a cleaning request appears, press the button: **Cleaning mode**
 7. Press the button **Forced cleaning**.
 8. Select the desired day of the week.
 9. Press the button **ON**.
 10. Set the time when you want to receive a reminder to clean the unit.
- >> The footer shows how long remains until cleaning needs to be carried out.

16 Care

WARNING

Fat or food residues in the cooking cabinet

If you do not clean the cooking cabinet sufficiently, there is a risk of fire from fat and food residues.

1. Clean the unit daily.
2. In the event of fire, leave the cooking cabinet door closed. This will remove the oxygen from the fire. Turn off the unit. If the fire has spread, use a fire extinguisher that is suitable to extinguish the fire. Never use a water or foam extinguisher to extinguish the fire.

16.1 General safety instructions

This will prevent scalding and burns:

- Let the unit and all function parts cool down before you perform any cleaning.

This will prevent material damage, injury or fatal accidents:

- When performing any cleaning works, except the automatic clean, turn off the unit from the power supply.
- Clean your unit daily even if you only use the manual steam mode.
- Do not clean the accessories/trays inside the unit when using automatic clean.

16.2 Care intervals

Care interval	Function parts
Daily	<ul style="list-style-type: none"> ▪ Cooking cabinet ▪ Press-fit door gasket ▪ Cooking cabinet door ▪ Drip tray and drain channel ▪ Core probes ▪ Accessories ▪ Hand shower
Weekly	<ul style="list-style-type: none"> ▪ Unit exterior ▪ LED cover ▪ Control panel ▪ Plastic parts
Monthly	<ul style="list-style-type: none"> ▪ Moistening nozzle

The functional parts must be cleaned according to the care interval, but can be cleaned more frequently if required.

16.3 Care products

Suitable care products

- Clean the following function parts with lukewarm water, a mild cleaning agent and a soft cloth:
 - Unit exterior
 - Cooking cabinet door glass panel
 - LED cover in the cooking cabinet door
 - Press-fit door gasket
- Clean accessories with lukewarm water, a mild cleaning agent and a soft cloth.

Unsuitable care products

Do not clean the unit, its functional parts and accessories with the following unsuitable care products:

- Scouring cleaning agents or abrasive cloths
- Substances containing hydrochloric acid, caustic solution, sulphur or other oxygen-requiring substances
- Undiluted alcohol, methanol or solvents such as acetone, benzene, toluene or xylene
- Oven cleaner or grill cleaner
- Steel wool
- High-pressure washer
- Sharp or pointed tools

16.4 Cleaning cooking cabinet door

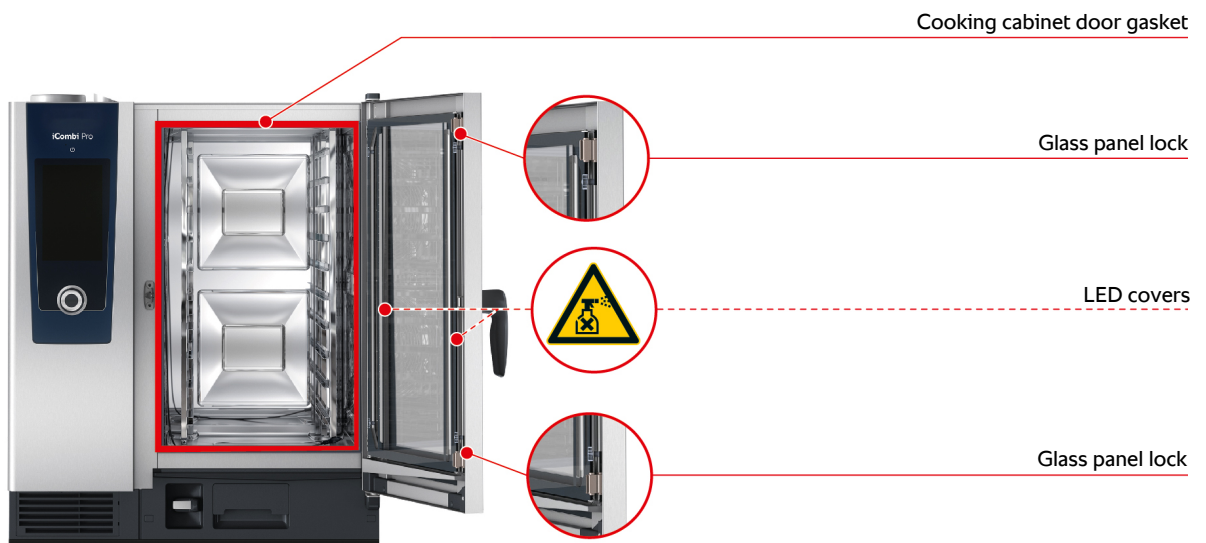

Clean glass panels

1. Open the cooking cabinet door fully until it locks into place.
2. Release the locks on the glass panels by pressing lightly.
3. Swivel the glass panes of the cooking cabinet door open one after the other.
4. Clean the glass panels of the cooking cabinet door with lukewarm water, a mild cleaning agent and a soft cloth.
5. Let the glass panels of the cooking cabinet door dry completely.



Clean LED covers

Once you have cleaned the glass panels of the cooking cabinet door, you can also clean the LED covers. Only clean the LED covers with suitable care products [► 91].

The LED cover is between the middle and the front glass panels of the cooking cabinet door.

- ✓ The glass panels of the cooking cabinet door are unlocked.
1. Clean the LED cover with lukewarm water, a mild cleaning agent and a soft cloth.
 2. Let the LED cover door dry completely.
 3. Lock all glass panels of the cooking cabinet door back into place.

Clean the cooking cabinet door gasket

If you operate your unit in continuous operation and at high cooking cabinet temperatures above 260 °C and mainly cook fatty and gelatinous food, the cooking cabinet door gasket can quickly become worn. To increase the life of the cooking cabinet door gasket, clean these daily.

- ✓ The cooking cabinet door is open.
1. Clean the cooking cabinet door gasket with lukewarm water, a mild cleaning agent and a soft cloth.

- Let the cooking cabinet door gasket dry completely.

16.5 Descaling the moistening nozzle



Required tool

- Hexagon key

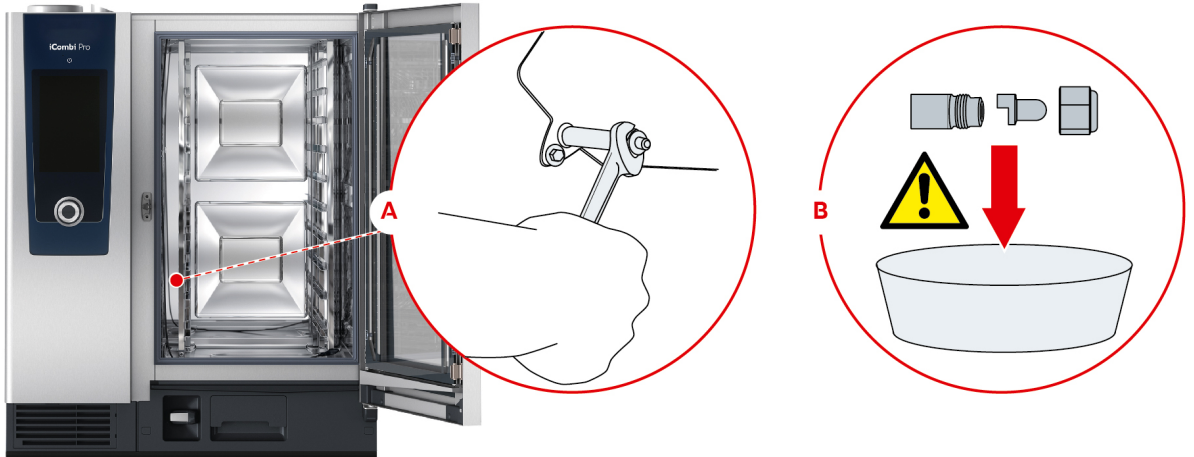

- Turn off the unit.
- Remove the left rack and swing the air baffle in the middle of the cooking cabinet.
- Loosen the nut of the steaming nozzle with the hexagon key (A).
- Remove the steaming nozzle.
- ⚠ WARNING! Danger of chemical burns! Wear a mask and chemical protective gloves for reliable protection when handling descaler.** Place the steaming nozzle in descaler (B).
- Leave the steaming nozzle in the descaler until the scale is dissolved.
- Remove the descaled steaming nozzle from the descaler.
- Rinse the steaming nozzle thoroughly with water and then leave it to dry completely.
- Reassemble the steaming nozzle in reverse order.

16.6 Cleaning the air filter



Required tool

- screwdriver

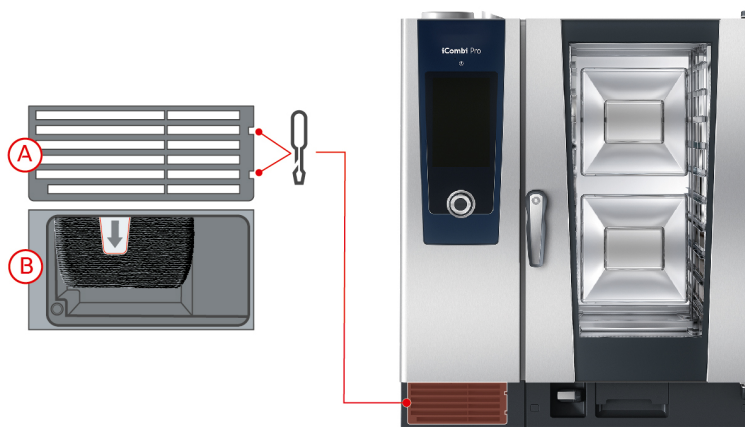

- Insert the screwdriver in the recesses of the air filter cover (A).
- Remove the air filter cover.
- Pull out the air filter (B).

4. Clean the air filter in the dishwasher and then leave it to dry completely.
 - > If the air filter is not clean after washing in the dishwasher, it must be replaced.
5. If the air filter is clean, slide it back into the unit.
6. Reinsert the air filter cover into the unit.

NOTICE

Spraying water may damage the unit if the air filter is not correctly mounted

Protection from water jets from all directions is only assured with a correctly mounted air filter.

1. slide the air filter into the unit until it locks into place.

16.7 Cleaning the hand shower





1. Pull the hand shower hose out completely and hold it firmly.
2. Clean the hand shower and the hose with a soft sponge.
3. To remove stubborn scale, clean the hand shower and the hose with diluted vinegar.

16.8 Cleaning the control panel



If your unit is equipped with a lockable control panel, you have to unlock the lockable control panel and open the cover before cleaning the control panel.

Before you clean the display, you can lock it. This prevents accidentally starting cooking processes, performing actions or calling up functions.

1. Press and hold the button: 
 - > After a few seconds, the display lock will be activated and the symbol displayed: 
2. Clean the display with a soft cloth.
3. To lock the display, press and hold the button: 
 - > The symbol will be displayed: 
4. **⚠ CAUTION! Risk of cuts! The central dial has sharp edges. Wear protective gloves when cleaning the central dial and the surfaces below it.** Pull off the central dial by hand and without tools.
5. Clean the central dial and the surface below it with a soft cloth.
6. Replace the central dial.





16.9 Cleaning accessories

1. Let the accessories cool before cleaning.
2. Remove any food residues and layers of fat, starch and protein with a soft cloth.
3. In case of stubborn dirt, soak the accessories in lukewarm water and then remove the dirt with a soft cloth.

17 Inspiration and help

17.1 Search assistant

The search assistant is the search engine in your cooking system. It searches for intelligent cooking processes, settings and applications examples, as well as the operating instructions for your unit.

1. Press the button in the menu bar: .
2. Press the search field and enter the search term.
 - > The search results will appear as you are typing. The search results are categorised by **iCookingSuite** , **Settings**  and **Operating instructions** .
3. Press on the desired icon to display the search results.
4. Press on the desired help entry to see the search results.

17.2 Help displayed on the unit

These operating instructions and a large number of application examples from around the world are available in the unit for operational assistance. The application examples show you which food you can best cook with an intelligent cooking process. You will also find all information concerning load sizes and the use of special accessories.

The help function in the unit is context-sensitive. This means that you always see the latest help content on the displayed area on the display.

1. Press the button 
 - > The help function is opened and displays the appropriate help content.

17.3 Telephone help

ChefLine®

We offer a telephone consulting service to answer any questions you have about applications or recipes. Quick, simple, from cook to cook and 365 days a year. Simply call the ChefLine®. You will find the number on the ChefLine® sticker on the cooking cabinet door or at rational-online.com.

RATIONAL Service Partners



Our units are reliable and have a long service life. Should customers ever encounter technical issues; our RATIONAL Service Partners will provide fast, efficient assistance. Guaranteed spare parts supply and a weekend call-out team included. You will find the number at rational-online.com.

17.4 Help in a service call

17.4.1 Automatically transferring service data to ConnectedCooking

If you have connected your unit with ConnectedCooking, you can set it so that the service data is automatically transferred to ConnectedCooking at regular intervals.

- ✓ Your unit is connected with ConnectedCooking [[▶ 85](#)].

1. Press the button .
2. Press the button  **ConnectedCooking**
3. Next to **Automatically transfer service data**, press the button: **ON**

>> Service data will now transfer automatically to ConnectedCooking. You can view the data at connectedcooking.com or in the ConnectedCooking app.

17.4.2 Retrieving service data

You can retrieve the service data in the settings. Click here for more information: [Service \[\[▶ 79\]\(#\)\]](#)

17.5 Problem resolution

When an error message is displayed, you can swipe it away while you are waiting for assistance. The error message will be minimised and shown as a red symbol on the side. If you press on this symbol, the error message will be magnified again.

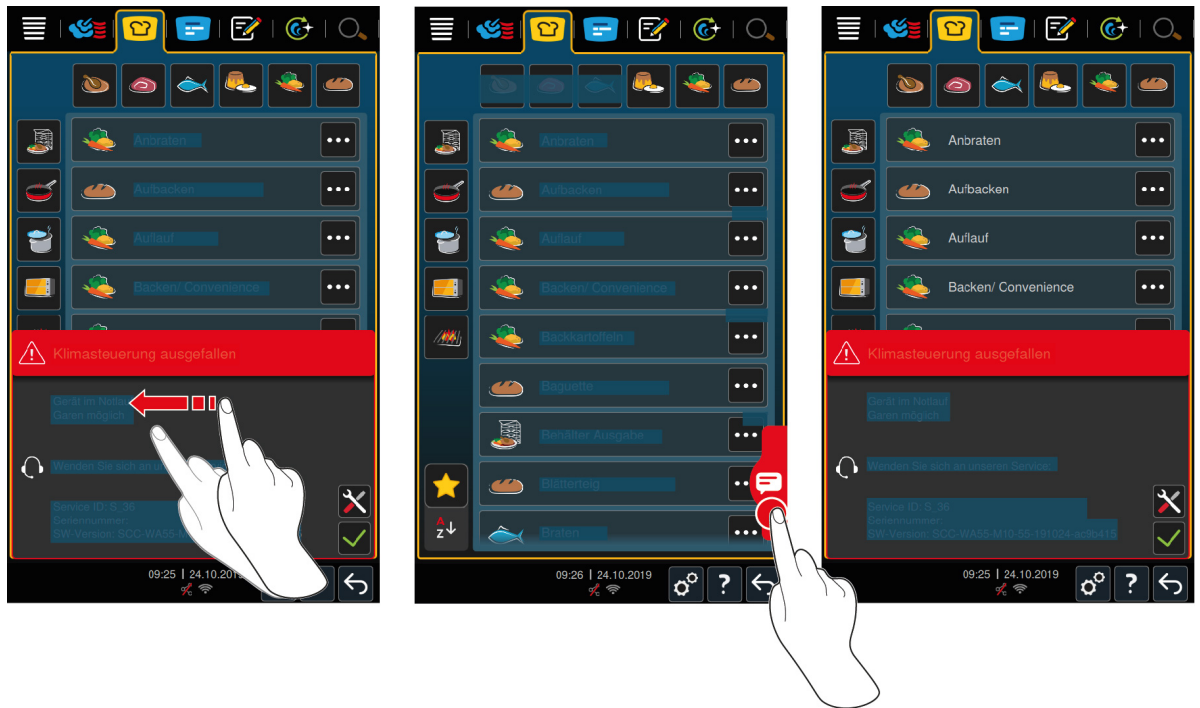

For all error messages, please contact your RATIONAL Service Partner. Always have the serial number of your unit ready. You can find the serial number on the model plate.

17.5.1 Error messages heating steam generator

Error report	Cause	Cooking possible
Service 10	The SC mechanism is faulty.	Yes
Service 11	The steam generator's water inlet is faulty.	Yes
Service 12	The measurement of the water quantity is incorrect.	Yes
Service 13	The water level in the steam generator is not recognised correctly.	Only the convection mode is available at the moment.
Service 20.8	The temperature probe is defective.	Only the convection mode is available at the moment.
Service 28.4	The temperature limit of the cooking cabinet has been exceeded.	Only the convection mode is available at the moment.
Service 42.1	The water supply is faulty.	Only the convection mode is available at the moment.
Service 43.1	The internal water supply is not closing.	Only the convection mode is available at the moment.
Service 46.1	The water supply is faulty.	Yes

17.5.2 Error messages for gas units

If your unit is connected to the gas supply, the following additional error message could appear. For all error messages, please contact your RATIONAL Service Partner [▶ 95]. Always have the serial number of your unit ready.

Error report	Cause	Cooking possible
Service 32.1	The gas burner is faulty. Close the shut-off valve on the gas line.	No
Service 32.2	The gas burner is faulty. Close the shut-off valve on the gas line.	No
Service 32.3	The gas burner is faulty. Close the shut-off valve on the gas line.	No
Service 33.1	The gas burner is faulty. Close the shut-off valve on the gas line.	No
Service 33.2	The gas burner is faulty. Close the shut-off valve on the gas line.	No
Service 33.3	The gas burner is faulty. Close the shut-off valve on the gas line.	No
Service 34.32	The internal data communication is faulty.	Yes
Service 60	The initialisation of the ignition box is defective. Switch the unit off and on again. If the error is still displayed, call your Service Partner.	–

17.5.3 Error messages heating hot air

Error report	Cause	Cooking possible
Service 20.1	The temperature probe is defective.	No
Service 28.1	The temperature limit of the steam generator has been exceeded.	No
Service 28.2	The temperature limit of the cooking cabinet has been exceeded.	No
Service 34.1	The internal data communication is faulty.	No
Service 34.2	The internal data communication is faulty.	No
Service 34.4	The internal data communication is faulty.	No
Service 42.3	The water supply is faulty.	The steam injection is not available.
Service 42.6	The water supply is faulty.	Yes
Service 43.3	The internal water supply is not closing.	Only the convection mode is available at the moment.

17.5.4 Error messages moisture

Error report	Cause	Cooking possible
Service 20.2	The temperature probe is defective.	Yes
Service 20.4	The temperature probe is defective.	Yes
Service 30	The humidity measurement is incorrect.	Yes
Service 36	The differential pressure sensor is defective.	Yes
Service 37	The differential pressure sensor is defective.	Yes
Service 42.2	The water supply is faulty.	Yes

Error report	Cause	Cooking possible
Service 43.2	The internal water supply is not closing.	Only the convection mode is available at the moment.

17.5.5 Error messages CleanJet

Error report	Cause	Cooking possible
Service 25	The water quantity required by the iCareSystem is too low.	–
Service 26	The ball valve cannot find the open position.	No
Service 27	The ball valve cannot find the closed position.	No
Service 34.8	The automatic clean does not work.	Yes
Service 43.6	The internal water supply is not closing.	Only the convection mode is available at the moment.
Service 47.1	The waste water pump is defective.	Yes
Service 47.2	The waste water pump is defective.	Yes
Service 48.1	The circulating pump is defective.	Yes
Service 48.2	The circulating pump is defective.	Yes
Service 110	An error occurred in the SC pump during the automatic clean.	No
Service 120	An error occurred in the water level recognition during the automatic clean.	No

17.5.6 Error messages Care

Error report	Cause	Cooking possible
Service 40	The quantity of care liquid required by the iCareSystem is too low.	Yes
Service 42.4	The water supply is faulty.	Yes
Service 43.4	The internal water supply is not closing.	Only the convection mode is available at the moment.
Service 49.1	The water supply is faulty.	Yes
Service 49.2	The water supply is faulty.	Yes

17.5.7 Notification centre

Error report	Cause	Cooking possible
Service 17	The unit model is incorrect.	No
Service 29	The board temperature is too high.	No
Service 31.1	The core probe in the cooking cabinet is defective.	Yes, you cannot use the core probe.
Service 31.2	The core probe in the cooking cabinet is defective.	Yes, but you cannot use the core probe.
Service 34.16	The internal data communication is faulty.	Yes
Service 34.64	The internal data communication is faulty.	Yes
Service 34.400	The internal data communication is faulty.	Yes
Service 41	The steam injection nozzle or the steam injection pipe has scale.	The steam injection is not available.

Error report	Cause	Cooking possible
Service 50	The real time clock on the CPU is not initialised. Set the date and time.	Yes
Service 51	The battery is defective.	Yes
Service 52.1	The cooking cabinet lighting is not working correctly.	Yes
Service 52.2	The cooking cabinet lighting is not working correctly.	Yes
Service 72	The activation temperature of a temperature probe has been exceeded.	No

18 Maintenance

You can perform the following maintenance work yourself:

- Replacing air filter [▶ 100]
- Replacing the cooking cabinet door gasket [▶ 101]

For the following maintenance work, contact your RATIONAL Service Partner:

- Replacing LED cover

18.1 Replacing air filter



Required tool

- screwdriver



✓ A message will be displayed that the air filter needs to be replaced.

1. Insert the screwdriver in the recesses of the air filter cover.
2. Remove the air filter cover.
3. Pull out the air filter.
4. Slide the new air filter into the unit until it locks into place.
5. Reinsert the air filter cover into the unit.

NOTICE

Spraying water may damage the unit if the air filter is not correctly mounted

Protection from water jets from all directions is only assured with a correctly mounted air filter.

1. slide the air filter into the unit until it locks into place.

18.2 Replacing the cooking cabinet door gasket



1. Open the cabinet door.
2. Pull the cooking cabinet door gasket out from the groove and dispose of it.
3. Moisten the retaining lips of the new gasket with soapy water.
4. First press the corners of the gasket into the corners of the groove.
5. Then press the rest of the gasket into the groove.

19 Transport

19.1 Transport unit

WARNING

The castors can be damaged if the unit or the Combi-Duo is moved with the parking brakes applied

If the castors are damaged, the unit or the Combi-Duo could tip over and seriously injure you.

1. Release the parking brakes on the castors before you transport or move the unit or the Combi-Duo.

WARNING

The castors can be damaged if the alignment of the castors is changed with the parking brakes applied

If the castors are damaged, the unit or the Combi-Duo could tip over and seriously injure you.

1. If the castors protrude from under the unit or the stand and you wish to change the alignment of the castors, first release the parking brakes and then turn the castors.
2. Do not kick against the castors.

CAUTION

Units could tip over when transported over thresholds or inclinations

When moving units over thresholds or inclinations, the unit could tip over and injure you.

1. Carefully move units over thresholds and inclinations.

CAUTION

Units and Combi-Duos on castors can tip over when transported or moved

If your unit is on castors or your Combi-Duo is on a stand with castors and you do not release the parking brakes before you transport or move the unit, the unit or Combi-Duo may tip over and injure you.

1. Release the parking brakes on the castors before you transport or move the unit or the Combi-Duo.
2. Apply the parking brakes again after transport.

You can move units that are on mobile stands or castors.

- ✓ The steam generator has been emptied.

1. Before you transport the unit to another location, you must properly disconnect the unit from the power supply and from the water and waste water pipes.
2. Once you have transported the unit to its new space, you must properly reconnect the unit to the power supply and the water and waste water pipes and apply the parking brakes on the mobile stand or the castors.



3. If you would like to pull the unit forwards slightly when cleaning the kitchen, release the parking brakes of the mobile stand or the castors.
4. Carefully pull the unit forwards.

5. Once you are finished with cleaning the kitchen, carefully slide the unit back into place and apply the parking brakes.

20 Decommissioning and disposal

20.1 Decommissioning

Contact your RATIONAL Service Partner if you would like to decommission the unit.

20.2 Disposal



Old units contain recyclable materials. Dispose of old units in an environmentally sound way using the appropriate disposal systems.

21 Technical data

Please also note the technical data on the model plate. The model plate is on the left next to the control panel.

21.1 Units with an electrical connection

	Value
Weight (without packaging)Model 6-1/1	99 kg
Weight (without packaging)Model 6-2/1	99 kg
Weight (without packaging)Model 10-1/1	127 kg
Weight (without packaging)Model 10-2/1	179 kg
Protection class	IPX5
Environmental conditions	10 – 40 °C
Airborne sound emission	≤70 dBA
Frequency and max. transmission power WLAN	2.4 GHz/19.5 mW

21.2 Units with a gas connection

	Value
Weight (without packaging)Model 6-1/1	117 kg
Weight (without packaging)Model 6-2/1	144 kg
Weight (without packaging)Model 10-1/1	155 kg
Weight (without packaging)Model 10-2/1	192 kg
Protection class	IPX5
Environmental conditions	10 – 40 °C
Airborne sound emission	≤70 dBA
Frequency and max. transmission power WLAN	2.4 GHz/19.5 mW

21.3 Models and version names

The model names and the version on the model plate are different. Please refer to the classification in this table.

Model	Version name
LMxxxB	iCombi Pro 6-1/1
LMxxxC	iCombi Pro 6-2/1
LMxxxD	iCombi Pro 10-1/1
LMxxxE	iCombi Pro 10-2/1

21.4 Conformity

21.4.1 Units with an electrical connection

This unit meets the following EU directives:

- Directive 2014/53/EU on the harmonisation of the laws of the Member States relating to the making available on the market of radio equipment
- Directive 2006/42/EU on machinery
- Directive 2014/30/EU on the harmonisation of the laws of the Member States relating to electromagnetic compatibility
- Directive 2011/65/EU Restriction of the use of certain hazardous substances in electrical and electronic equipment, including 2015/863/EU

This unit meets the following European standards:

- EN 60335-1:2012 + A11:2014 + A13:2017
- EN 60335-2-42:2002 + A1:2008 + A11:2012
- EN 61000-3-2:2014; EN 61000-3-3:2013
- EN 55014-1:2006+A1:2009+A2:2011; EN55014-2:2015
- EN 62233:2008
- EN 1717:2000

21.4.2 Units with a gas connection

This unit meets the following EU directives:

- Regulation (EU) 2016/426 on units burning gaseous fuels
- Directive 2014/53/EU on the harmonisation of the laws of the Member States relating to the making available on the market of radio equipment
- Directive 2006/42/EU on machinery
- Directive 2014/30/EU on the harmonisation of the laws of the Member States relating to electromagnetic compatibility
- Directive 2011/65/EU Restriction of the use of certain hazardous substances in electrical and electronic equipment, including 2015/863/EU

This unit meets the following European standards:

- EN 60335-1:2012 + A11:2014 + A13:2017
- EN 60335-2-42:2002 + A1:2008 + A11:2012
- EN 60335-2-102:2016
- EN 61000-3-2:2014; EN 61000-3-3:2013
- EN 55014-1:2006+A1:2009+A2:2011; EN55014-2:2015
- EN 62233:2008
- EN 203-1:2014; EN203-2-2:2006; EN 203-3-:2009
- EN 1672-1:2014
- EN 1717:2000

22 Regulatory Information

USA

This device complies with part 15 of the FCC Rules. Operation is subject to the following two conditions:

- (1) This device may not cause harmful interference, and
- (2) this device must accept any interference received, including interference that may cause undesired operation.

This equipment has been tested and found to comply with the limits for a Class A digital device, pursuant to part 15 of the FCC Rules. These limits are designed to provide reasonable protection against harmful interference when the equipment is operated in a commercial environment. This equipment generates, uses, and can radiate radio frequency energy and, if not installed and used in accordance with the instruction manual, may cause harmful interference to radio communications. Operation of this equipment in a residential area is likely to cause harmful interference in which case the user will be required to correct the interference at his own expense.

FCC ID: 2AUI6-LM1

Index

A

Abort	42, 48
Abort cooking process	39, 42, 48
Air filter	
Cleaning	93
Air speed	39, 44
Automatic cleaning	
Cleaning programmes	88

B

Boiling temperature	43
Brushing	39

C

Cabinet door	
Clean gasket	92
Clean LED cover	92
Cleaning	92
Cabinet temperature	38, 43
Combination of steam and hot air	46
Convection	46
Steam	45
Care	
Accessories	94
Control panel	94
Care products	
Suitable cleaning agents	91
Unsuitable cleaning agents	92
Carve	39
Central dial	17
Cleaning	92
Clean LED cover	92
Cleaning	
Air filter	93
Cabinet door	92
Cooking cabinet door gasket	92
LED cover	92
Quick clean	88
Cleaning programmes	
Light	88
Medium	88
Strong	88
Cockpit	41
Confirm action	39
ConnectedCooking	
Register the unit without smartphone	85
Register with smartphone	85
Continuous operation	38
Control panel	
Clean central dial	94
Cleaning	94
Cooking cabinet climate	
Combination of steam and hot air	46
Convection	46
Steam	45
Cooking cabinet humidity	37, 38
Cooking level	38

Cooking time	38
Cool-down function	44
Core probes	
Baked goods	23
Error report	23
Fish fillets	23
Inserting into the food	22
Large pieces of meat	22
Remove	24
Small food item	22
Steak	22
Vegetables	23
Whole fish	23
Core temperature	38
Crisp	41

D

Delta-T cooking	38
descaling	
steaming nozzle	93

E

Examples of use	95
-----------------	----

F

Fill up	39
Flash steam	39
Food thickness	37
Forced cleaning	90
Frying level	37

G

Gas smell	12
-----------	----

H

Hand shower	24
Spray	24
Hold	40
Hold core temperature	40
Humidification	39, 44

I

iProductionManager	
Combination check	57
Placement logic	57

L

Load sizes	95
Loading the unit	39

M

Maintenance	
-------------	--

Replace air filter	100
Replace gasket	101
Manual cooking	
Combination of steam and convection heat	46
Convection	47
Steam	45
Move core probe	40
Moves	17

N

New batch	40
-----------	----

O

Online help	95
Operating the unit	
Central dial	17
Moves	17

P

Performing maintenance yourself	100
Pierce	39
Preheat	40

R

Replace air filter	100
Replace gasket	101
Reset core probe	39
Residual time	40
Rinse	88
Cleaning programs	88
Roast	39

S

Size of food	37
Sous-vide cooking	
Cook and chill	49
Fields of use	49
Room service	49
Special diets and clean eating	49
Special accessories	95
steaming nozzle	
descaling	93
Switch off the unit	14
Switch on the unit	14

T

Time continued	41
----------------	----



Metos Oy Ab

Ahjonkaarre, FI-04220 Kerava, Finland

tel. +358 204 3913

www.metos.com