

# metos

## SLICER

**METOS MARINE  
G250, G300, G330**

### Installation and Operation Manual



8.1.2016

MG4080232, MG4080232ME, MG4080232MW, MG4080236, MG4080236ME, MG4080236MW, MG4080238, MG4080238ME

# 1. CONTENT ORGANIZATION AND CONSULTATION

## ***PURPOSE of the MANUAL***

### **KEEPING THE MANUAL**

This manual must be considered as an **integral part of the machine**:

1. It must be kept for the entire life of the machine.
2. It must be given to the person who will use and maintain the machine.
3. Beyond containing all the information necessary for the operators, it includes (divided in specific chapters) the electric diagrams to be used for maintenance and reparation.

### **SCOPE / MANUAL PURPOSE**

This instruction manual **has the purpose** to provide the user with all the information necessary for a safe use and of these machines. Besides, this publication provides with all the **indications and warnings** to take every precaution, to understand the machine's principles and functioning limits. For any explanations or doubts on the contents please contact an Authorized Assistance Center.

### **RECEIVERS**

This manual (1 copy) comes with the machine and must be considered as an integral part of the machine. It is meant for those people who will use and maintain the machine.

The slicers must be used only by suitably trained personnel who has carefully read the contents of this manual.

### **RESPONSIBILITY**



- In case of need (ex. any damage to even a part of the manual that makes consulting it difficult) the use must acquire a new copy from the Authorized Assistance Center.
- The present manual reflects the technical state during the machine manufacturing; The descriptions and illustrations contained in this manual are not binding. The manufacturer reserves the right to introduce any modification without updating the manual.
- Pay particularly attention to the residual risks content present on the machine and the prescriptions that operators must follow.
- The manufacturer is responsible only for the machine as it is in its original configuration.
- The manufacturer declines all direct or indirect responsibility deriving from improper use, untrained personnel using the machine, not following the instructions in the manual, outstanding events, using the machine so that it does not conform to specific regulations in force in the country of installation, unauthorized changes and/or repairs to the machine.
- The manufacturer declines all direct or indirect responsibility deriving from the use of accessories and spare parts that are not original.
- The manufacturer is responsible for the information contained in the Italian manual version only.
- The warranty is voided by any non-fulfillment of the information contained in this manual.

The person in charge for supervising the working activity must:

- Respect the safety norms contained in the manual.
- Make sure the operators are informed about the specific risks they undertake when using these machines and conform to the specific safety rules
- Have more than one user operating the machine

## SYMBOLS USED IN THE MANUAL



### **DANGER**

Shows a possible danger for those who are using the machine and the nearby persons. Therefore, it signals that the operation taking place must be performed respecting all the safety norms contained in the manual



### **PRECAUTION**

Shows a warning on useful information and/or further recommendations and/or suggestions about the actual operation.



### **ATTENTION**

Shows an operation to be performed thoroughly to avoid damaging the machine.

## 2. GENERAL INFORMATION AND CHARACTERISTICS

### USE AND PARTS

The slicing machine hereinafter referred to as “machine” is designed and manufactured with a circular blade mounted in a tilted position. This blade is driven by an electrical motor driven by belt transmission in order to slice foodstuffs. Slice thickness is adjustable. The products that can be sliced include: all types of cold cuts, boneless meat (cooked or raw at a temperature of no lower than +3°C); for cheese slicing, please use a Teflon blade.

The machine housing that supports the cutting tool is made of anodized aluminium alloy. The anodizing electrolytic process grants hygienic food contact and high resistance to the oxidization.

The blade is made of 100Cr6 steel (chromed). The blade is designed and tempered to assure precise cut even assuring an exact and after its re-sharpening.

Other components of the machine are made of food grade polycarbonate and stainless steel.

The machine can be:

- **Vertical:** the machine food table is parallel to the horizontal surface.  
The food table is equipped with a special cold meats food press handle.
- **Gravity:** the machine food table is inclined to the horizontal surface.  
The product to cut moves gravity way to the blade
- **Meat Slicer:** the machine food table is parallel to the horizontal surface.  
The food table is especially designed for meat cuts.

The machine base is supplied with by anti sliding rubber feet.

The machine is equipped with a carriage holding a product tray and sliding on a bar mounted under the base top, parallel to the blade. Slice thickness is adjusted by means of a gauge plate mounted in front of the blade, and regulated by turning the graduated scale knob.

The food product is fed and removed manually.

The machine comes with an identification plate on which the following data are showed:

<b>Mod.</b>	<b>Hp</b>	
<b>Nr.</b>	<b>kW</b>	
<b>1N PE AC. 230V 50Hz</b>	<b>A</b>	
<b>Kg.</b>	<b>2011</b>	<b>kA</b>

## GRAVITY SLICING MACHINE TECHNICAL AND MANUFACTURING DATA

TECHNICAL DATA	MODEL					
	G220	G250	G275	G300	G330	G350
Power (kW) / (Hp)	0.25/0.35	0.25/0.35	0.27/0.40	0.27/0.40	0.38/0.50	0.38/0.50
Blade diameter (mm)	220	250	275	300	330	350
Cut capacity (mm)	170x210	190x250	160x230	160x230	240x250	240x250
Cut regulation (mm)	0 ÷ 15					
Trolley run (mm)	240	260	270	270	330	330
Weight net (kg)	13	19	22	23	38	40
Sizes A x B x C x D x E (mm)	400x450x370 x400x300	580x470x370 x470x310	500x630x420 x470x320	500x630x420 x470x320	500x780x480 x600x420	500x800x480 x600x420

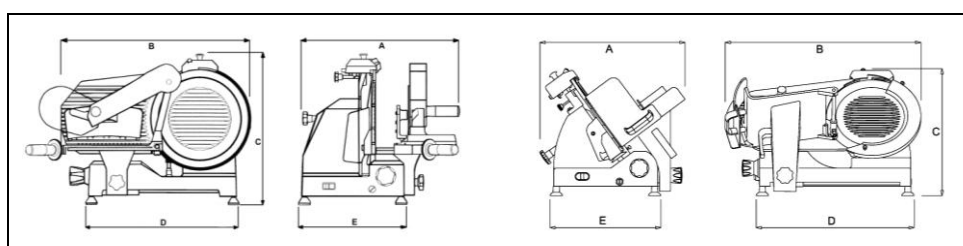

Continue acoustic power level considered equal to A	Less than 70dBA
Current nature – Frequency	Rating plate
Full charge current	Rating plate
Use nominal voltage	Rating plate
Auxiliary circuits voltage	AC 24V – DC 24V
Mass and neutral	TT e TN
Protection degree	IP X3
Use	In doors only
Machine positioning	<b>Test bench used in the feed sector</b> of height included between <b>900/1100mm</b> from the threading surface of adequate capacity, with a circulation free space of at least <b>800mm</b>
Environment air max. temperature	-5 / +40°C -
Environment relative max. humidity	90%
Requested minimum illumination	500 lux
Product directive conformance	<b>2006/42/CE and successive modifications and integrations, Reg. 1935/2004</b>

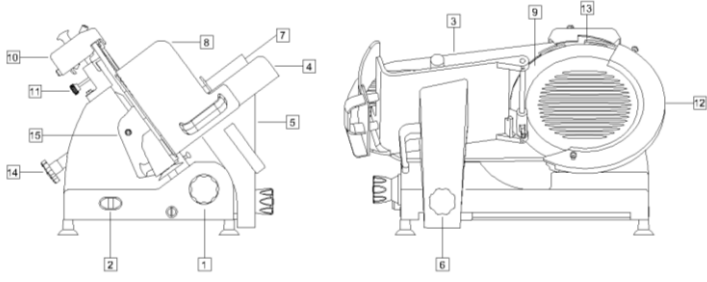
GROUP	EXAMPLE
<ol style="list-style-type: none"> <li>1. graduated scale knob</li> <li>2. on/off push buttons</li> <li>3. gauge plate</li> <li>4. food table</li> <li>5. carriage tray</li> <li>6. product tray handle</li> <li>7. food press</li> <li>8. product tray hand protection</li> <li>9. blade</li> <li>10. sharpener</li> <li>11. sharpener knob</li> <li>12. blade cover</li> <li>13. blade guard ring</li> <li>14. safety guard</li> </ol>	 <p data-bbox="343 629 639 656"><b><u>GRAVITY SLICING MACHINE</u></b></p>

## NORMAL USE, IMPROPER USE, INCORRECT OR FORBIDDEN USE

The slicing machine must be used only by an adequately trained person who has carefully read the contents of this manual. The operators must be, in perfect mental physical condition, have the right attitude and capacity and necessary knowledge for maneuvering and normal maintenance of simple mechanical and electrical components.



Under its **NORMAL USE** the machine is designed and manufactured with a circular rotating blade used to slice food products of different type and size



The machine must not be used **IN IMPROPER WAYS**, in particular:

1. it must not be used for domestic use
2. it must not function with parameters different from the ones showed in the technical characteristics table
3. The manufacturer declines all direct and indirect responsibility deriving from any use of the machine that is different from the ones described in this manual
4. the user is responsible for any damages deriving from the non-fulfillment of the instructions contained in this manual
5. never operate the machine without food products
6. never operate or remove all Warning Labels Attached and Owner/Operator Manual Available to the Operator.
7. any improper use of the machine might cause risks for people's health and safety.



NEVER use the machine in **INCORRECT OR FORBIDDEN WAYS** to avoid serious personal injury. It is forbidden:

1. to **move the machine while still plugged in**
2. to unplug **the electric feeding cable** to switch off the machine
3. to place any weights on the machine and/or the electric feeding cable
4. to **put the electric feeding cable** close to cutting parts or flammable ones
5. to use the machine with the **electric feeling cable or with the control devices** damaged and not intact
6. to **leave the machine switched off** with the electric feeling cable connected to the feeding plug
7. to **leave machine unattended** while operating.
8. to **insert any objects into** the motor ventilation fan
9. **not to install** machine on a level, solid, non-skid surface in a well-lighted work area ranging between 900-1100 mm high from the floor area
10. to insert **any objects or clothes** under the machine base and/or between the machine rubber feet and work bench
11. to **use any inflammable, corrosive or abrasive detergents for cleaning the machine**
12. to **immerse the machine** in water or any other liquids
13. **the use by unauthorized personnel** and with loose clothing or different from those showed in this manual
14. to **use the machine for products different from** the ones described in this manual (i.e. bones, frozen meat, not feed products, or other non-food objects such as scarves, etc..)
15. to **remove any machine parts while** the machine is working or there is any product leftovers on the food plate
16. to **operate** the machine before all possible **residual risks have been eliminated**
17. to **smoke or use equipment with free flame** and use inflammable materials, unless suitable safety measures have been taken
18. to **loose any knobs during operation or 5 sec after the machine has been stopped,**
19. to operate the machine whilst **the safety protections are not correctly locked or removed**
20. to **remove even partially any protections or danger signals**

21. to **remove the blockage or operate control devices without proper authorization**
22. to **push the feeder with bare hands** on the food plate
23. to **manoeuvre or use the machine** with wet or humid hands (the knob hold can be slippery)
24. to **touch the moving elements while the machine is working and/or 5 sec after machine has been stopped**
25. to **place the machine on trolleys, stirrups or unsteady tables;** during operation the machine could fall causing damages to things and accidents to people
26. to **cut deep-frozen feed products, meat with bones, fish, cheese or any other vegetables**
27. to **touch the blade with bare hands or with other object** while the blade is rotating
28. to unlock the blade while it is rotating and/or while the machine is still plugged in



**The user is however responsible** of the damages resulting from the failure to comply with the instructions contained in this manual. For any doubts, please contact any Authorized Assistance Centre.

### 3. SAFETY INSTRUCTIONS

#### INTRODUCTION



**Negligence of standards and safety procedures** can cause danger and damage.

When operating the machine **the users must respect:**

1. all rules, concerning the environment and human behaviour, established in the applicable laws and/or standards; with particular reference to the fixed plant upstream of the machine and for its connection/functioning;
2. all further instructions and use warnings making part of the technical/graphic documentation annexed to the machine.



Except where differently specified, the **personnel which performs the installation interventions, connection, maintenance, reassembly, and reuse, damages or breakdowns, demolition and dismantling** must be **skilled personnel** with expertise in safety matter and residual risks.

#### **ENVIRONMENTS, WORKING AND PASSING PLACES**

The work environment must comply with the requirements of the 89/654/CEE requirements. To avoid serious personal injury properly install equipment in adequate work area. **The employer** must comply with the directive 89/391/CEE relative to employee's safety and health improvement, and make sure that any residual risk is reduced or prevented.

#### **WARNINGS ON THE RESIDUAL RISKS**

##### **RESIDUAL RISK DUE TO THE FIXED PROTECTIONS REMOVAL, INTERVENTIONS ON BROKEN/WORN PARTS**



**the operator must not try by any chance to open or remove a fixed protection or tamper a safety device.**

**During the installation, maintenance, parts replacement and cleaning phase and/or during any manual operation that includes the introduction of hand or any other body parts, please be aware of the residual risks, such as:**

1. **hits against the machine parts**
2. **Grazing and/or abrasion against the machine rough parts**
3. **Pricks due to sharp parts**
4. **Cuts due to sharp**



the **loading** phase is particularly risky because it is meant to be done by hand, and this might cause a residual risk of cuts due to sharp parts. Besides in the **cleaning or stuck pieces unblock in the blade** that happens also introducing the hands near the cut tools, there is a residual risk due above all to a **cut with tools sharpened parts.**

The operator and the Service person **must be trained for any intervention relative to operations that must be done while the lid is open.** They must be aware of consequent risks and must be authorized by a supervisor and must use adequate individual protection devices and always wear **five fingers anti cut gloves.**



## PROTECTION DEVICES ON THE MACHINE



The machine protections and safety devices must not be removed. If they have to be removed for any extraordinary maintenance **some measures will have to be immediately adopted in order to inform of any risks and avoid any injuries.**

All the safety devices must be put back in place once the need for temporary removal is over.

All machine protection and safety devices must be maintained in perfect and constant efficiency condition.

**The machine transmission parts are completely isolated by means of fixed protections which don't allow the access for any kinematical chain.**

Given all the machine use modality and its use destination, please note that the moving parts are not isolated from the other mobile protections and safety devices.

All the **safety functions** including the control systems parts connected to safety have been tested according to proper safety components and principles.

**Protection devices included in the machine:**

<p><b>Hand protection:</b> protection in polycarbonate that prevents the blade contact with the fingers when the hand is placed on the food tray handle.</p> <p><b>Food press knob:</b> knob equipped with metal ring and spacer that prevent the blade contact with the fingers when the hand is placed on the food tray handle</p>	
<p><b>Sharpener:</b> placed over the blade includes all the parts necessary to sharpen the blade and prevents the access to the blade superior part. It isn't used during the cutting process.</p> <p><b>Blade cover:</b> covers the blade leaving free only the usable part for the cut. It is removable thanks to a unscrewing tie-rod placed on the blade back</p>	
<p><b>Blade cover ring:</b> covers the blade leaving free only the usable part for the cut.</p>	
<p><b>Tray removal:</b> the carriage on which the food plate Food plate which can only be removed if the regulating knob of the thickness plate is in the 'zero' position (1) and the carriage is at the end of its position on the operator's side (2) then lift the carriage upwards (3)</p>	

## 4. TRANSPORTATION, PUT IN SERVICE AND USE



**The machine can be operated by authorized and properly trained personnel**

**Before to switch on the machine** perform the following operations:

- Read thoroughly this manual
- Be informed about the protections and emergency devices that are available on the machine, their localization and their functioning.

**The non-authorized use** of commercial parts and accessories included in the protections and in the safety devices can provoke the mis-functioning of the machine and risks for the operator.

**The operator besides must** have received an adequate training.

### WORK PLACES AND OPERATOR TASKS

As prescribed in the instructions manual for the use, the machine is designed to be operated by an **operator** trained and formed on the residual risks, but with the competences, in safety matter, of the maintenance men.

The operator normal work zone is:

1. the machine anterior zone near the food platform for the food product loading / unloading operations and for the trolley activation.
2. the machine back zone near the binder surface to grasp the cut food product slices.
3. the zone around the machine near the control devices, the knobs, etc... for the switching on, regulations and switching off operations.

### TRANSPORTATION, MOVING AND STORING

All transportation and movement measures must be carried out by **properly trained personnel and adequately informed and trained staff who has read and understood** the safety instructions in this manual. Necessary:



1. the movement and transport of the machine always be carried out when it is discharged,
2. to verify that the lifting means are able to bear the weight and the load volume under safety conditions and that these are tested and the proper maintenance subjected,
3. to take all measures that are necessary to ensure the maximum stability of the funds and charges in relation to their mass and their priorities,
4. to prevent the machine during its repositioning and unloading sudden shocks or accidental blows suffered,
5. perform the movement with continuous movements without causing jerks occur or repetitive pulses.

### PACKING REMOVAL

#### **PACKING DESCRIPTION – DISPOSAL OF THE PACKING MATERIAL**

The machine and the various parts delivered separately are packed so that infiltration / penetration, of liquids of organic material or human beings are avoided. The packing consists of **polyethylene sheath around the machine**, and the whole is packed in a **cardboard box** of sufficient size, the box is placed on a wood pallet. The empty spaces in the box are filled with the **filling material**.

Do not dispose, but restore it for possible transportations or recycle.

The evaluation and the management for the products biological compatibility used in the packing are of user competence and responsibility.

The employer is obligated to **know the applicable laws of his country and to work so that these laws are complied with**.

**It is forbidden and punishable by the law to dispose** the machine and the electric equipment in the environment.

## PREPARATION PRELIMINARY OPERATIONS

### STABILITY

The machine stability is designed so that, in the foreseen functioning conditions, taking into account of the climatic conditions, is such to allow it the use **without spilling risk, of falling, or of unexpected movement**.

Tenuto conto della conformazione e della sua posizione, quando posta su un banco di lavoro stabile, privo di ruote e solido, la macchina risulta essere intrinsecamente stabile senza necessità di fissaggio al banco di lavoro.

### ELECTRIC FEEDING

The electric feeding connection must be in conformance with the **actual legislation in the country where is used**.

**The electric feeding** must be maintained in conformance with the following technical prescriptions:

1. **the electric feeding** must be always of the type and have an intensity corresponding to the specifications showed in the electric equipment plate. If excessive tensions are applied, some components will be damaged irreparably,
2. **a differential device must be foreseen** coordinated with the protection circuit, respecting the legislation and the actual regulated and legislative disposals in force in the installation country;
3. **the cable for the electric panel feeding outside the cover** must pass in the spaces prepared from You and adequately protected;
4. if present **the neutral conductor (N)** before feeding the electric equipment, from You its continuity must be guaranteed (connected and available).
5. before feeding the electric equipment from You its continuity must be guaranteed (connected and available) of the protection equipotential circuit green yellow conductor; besides a differential protection switch must be present with calibrations not superior to 30mA, in conformance with the standard IEC 60364 last issue.



### ELECTRIC FEEDING SECTIONING DEVICE

The feeding sectioning device, as comparable from what described from the power circuits diagram delivered with the machine, must be foreseen for the unique **machine feeding** source.

In case of incompatibility between the net socket and the equipment plug **make change the socket with another one suitable from the maintenance personnel**.

The feeding sectioning device allows **separating (insulating) the machine electric equipment** from the feeding, with the aim to make possible the interventions performing without electric shocks risks.

The sectioning device presents two possible positions:

	
OFF or "disconnected", the electric equipment results sectioned from the electric feeding	ON or "inserted", the electric equipment results connected to the electric feeding

### BLADE ROTATION



The here follow showed operations must be performed from the machine maintenance am (**personnel specialized in the industrial machines electric maintenance field**).

**For machines fed with three phase tension** (3 PE AC 400V 50Hz) during the switching on verify that the blade **rotates in anticlockwise**.

**If there is a clockwise rotation**, switch off the machine, disconnect the plug, disassembly, disconnect two phase conductors, invert them of position, reassembly all and connect again the machine to the net.

### FUNCTIONING DESCRIPTION

The control devices are designed and manufactured so that are much safe and reliable and resistant to the service normal stresses, to the foreseeable efforts and to the external agents. Besides they are clearly visible and countersigned from a suitable marking. Here follow the main **control devices** are showed:

TYPE / COLOR	REFERENCE / DESCRIPTION
Button / black	"0" / button for the machine stop control
Button / white	"1" / button for the machine starting control
Lamp / white	Luminous gem that lights when the machine is in function

## **STARTING**

The machine starting is possible only **with a voluntary action on the control device foreseen for this aim**: button "I" for the machine start control.

## **STOP**

For the stop control activate the button "0". In case of **temporary or prolonged stop**, before putting in function the machine all food products placed on the food platform case plate must be removed.

## **TENSION ABSENCE**

In case of electric feeding disconnection or if the machine is disconnected from the electric net, this last one will be able to be restarted only following the starting function, **after the electric feeling return or the reconnection to the electric net**.

## **CHECKS AND CONTROL BEFORE STARTING**

<b>CHECKS</b>	<b>METHODS AND FINDINGS</b>
<b>Make sure:</b> ➤ <b>that the machine's food platform, sail and the collector are free of foreign objects.</b>	Visual control of the parts specified, to ensure that no foreign objects or remaining of various tools, clothes, etc. and no food products are not present. In case of presence it is necessary to remove them.
<b>Ensure cleanliness:</b> ➤ <b>of the food platform and its groups,</b> ➤ <b>of the blade, the sail and the blade cover disc</b> ➤ <b>the collector</b>	Visual control of the internal parts provide for its removal. In case of mould or other type of dirt presence, clean parts in accordance with the indications of the chapter 5
<b>Ensure integrity:</b> ➤ <b>Of the fixed guards</b>	All fixed fixed guards, as well as the mobile ones, etc... must perform the function for which they were provided. Visual inspection of specified parts to ensure their integrity on the outside of their surface. The parts must be replaced at the first signs of erosion or breaking.
<b>Ensure functionality:</b> ➤ <b>of the control</b> ➤ <b>check control relating to safety;</b> ➤ <b>of the control devices.</b>	All devices must perform their foreseen function for which they were provided. Directly control the devices so that they determine the function of waiting. The actuators and all parts must still be replaced at the first signs of erosion or rupture.
<b>Check:</b> ➤ <b>of no strange noises after the start</b>	In case there are strange noises, due for example to mechanical breakings, <b>stop the machine immediately and unplug it from the power supply.</b> <b>Call service</b>

For any type of assistance or for the replacement of parts that are damaged, turn the maintenance service . Any replacement must be made with the original spare parts or at least of quality, safety and equivalent characteristics . For further information contact your Authorized Service Center .

## **PUT IN OPERATION**

The operator can operate the machine, in order bt following the instructions below:

1. place the machine on a steady surface so that the switch is to be in front of the operator,
2. positive outcome of the checks referred to preliminary preparation,
3. positive outcome of the checks referred to the power supply,
4. positive outcome of controls aimed at ascertaining compliance with alla the conditions of security,
5. insert the plug into the wall socket,
6. move back the food platform towards the operator and rotate the handle to the outside of the meat pressing.
7. place to product to be cut on the food platform on contact with the sail
8. turn the graduated knob to decide cut thickness from "0" to "15"
9. block the food with the appropriate goods press
10. turn on the main switch and check that the indicator lamp switches on,
11. take the hold of the handle on the food platform and push the plate advancing it slowly towards the blade, taking care of to maintain a slight pressure against the sail. **It is forbidden to push the ingredients with hands,**
12. the food will be easily cut from the blade and the slices, guided from the appropriate slice protection will fall on the food collector,
13. after cutting is finished, **switch off the machine, turn the switch in position "0" and disconnect the machine from power supply by removing the plug from the wall socket.**



**It is recommended not to operate the machine without the food product.**

## **SWITCHING OFF**

In succession, the switching off must be followed as indicated below:

1. before switching off wait till cutting ends,
2. stop the machine by turning the switch into the position "0",
3. disconnect the machine plug from wall power supply,
4. clean the machine

## BLADE SHARPENING

Blade should be sharpened periodically and as soon as decrease in cutting. Please follows the following instructions:

1. turn OFF the machine, return the sail to position "0" and unplug the power supply
2. carefully clean the blade with denatured alcohol to decrease,
3. Loosen the knob (1), lift the sharpener (2) and rotate it 180 °; put up to the stroke end so that the blade is between two grindstones,
4. insert the plug into the wall socket,
5. switch the machine on and check the indicator light comes on,
6. press the push-button (3), let the blade in contact with the grindstone for about 30/40 sec, a slight burr forms on the blade.
7. press for  $\frac{3}{4}$  sec simultaneously buttons 3 and 4 and then leave to go at once. **Don't prolong the operation beond the 3 / 4 sec to avoid the damaging blade edge retaliation.**
8. replace the sharpener to its original position, by reversing the procedure.

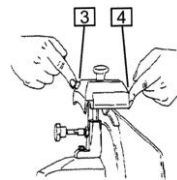
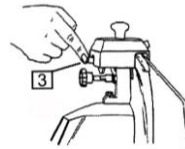
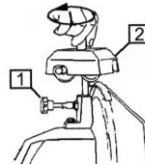

**The slice blade must be changed when it does not withstand further sharpening or when the distance between the blade and the protection ring exceeds 6 mm.**

## 5. MAINTENANCE, TROUBLE SHOOTING AND CLEANING

### ***MAINTENANCE REQUIREMENTS***

With the term “**maintenance**” must not be understood only a periodic control of the normal operation, but also the analysis and the resulting remedy of all causes that for any reason puts the machine it out of service.

It is absolutely necessary for the **maintenance, cleaning, replacement parts and troubleshooting** performed from the user, that **this task is entrusted to an experienced, competent and authorized service person.**

**All maintenance, cleaning and part replacement, without exception, must be strictly carried out with the MACHINE STOPPED AND ISOLTED FROM THE POWER SUPPLY.**

### **REMOVAL OF GUARDS AND/ OR PROTECTION DEVICES**

For some cases presented in this chapter, it is necessary to remove some fixed gurads.

The removal can happen only by a trained service person.

**After the maintenance or repair work, the GUARDS must be replaced and locked in their original positions.**

**The maintenance responsible must disconnect the machine completely, before removal of a fixed guards and/or replacement of any component.**

### **INSULATION FROM THE EXTERNAL POWER SOURCES**

Before performing any **maintenance, cleaning and replacement of parts, the machine must be stoped and isolated from the power supply.**



Position “ZERO” the protective device placed upstream of the electric feeding line.



Switch off Disconnect the general sectioning device\_and provide to protect the plug with appropriate systems

## CLEANING



**It is forbidden to clean the machine or its parts when in operation.**

All cleaning work must be put in place exclusively , after discharging car with the food being processed and have it isolated from the electrical power source and external energy .

The machine and the machine board components **must not be ever washed using water, nor in form of jets of any nature and quantity; so, without “bucket” nor “rubber” nor “sponge”**. Don't put ever directly the machine in the sink or under the tap.

**The machine hygiene level classification, for the foreseen use, is 2 (two):** machine that, after a hygiene risk evaluation is conformance with the applicable international standards requirements, but requests a disassembly programmed for the cleaning.

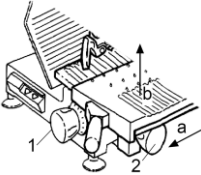
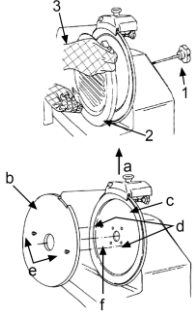
FREQUENCY	PERSONNEL	ACTIONS
At the end of every blade sharpening operation	Operator	<p><b>SHARPENER CLEANING</b></p> <ol style="list-style-type: none"> <li>switch off the machine and disconnect the feeding cable</li> <li>wear metal gloves</li> <li>clean the grindstones with a soft brush, dipped in denaturated alcohol. The stones must always be in the safety position: with the grindstones facing the side opposite to the blade.</li> </ol>
At the end of each shift and before the daily use	Operator	<p><b>GOODS CASE TROLLEY CLEANING</b></p> <ol style="list-style-type: none"> <li>switch off the machine and disconnect the feeding cable</li> <li>wear metal gloves</li> <li>remove the group consisting of flat door goods, handle and legs: <ul style="list-style-type: none"> <li>➤ turn knob (1) to the level “0”</li> <li>➤ bring the trolley into the end of stoke (a) from the control side</li> <li>➤ unscrew the knob (2) and pull the trolley up (b)</li> <li>➤ clean group consisting of goods food platform, arm with the under specified products</li> </ul> </li> <li>reposition the group in reverse way</li> </ol> 
At the end of each shift end and before the daily use	Operator	<p><b>CLEANING OF BLADE, BLADE GUARD, PROTECTION RING</b></p> <ol style="list-style-type: none"> <li>turn off the machine and disconnect the feeding cable,</li> <li>wear metal gloves (3)</li> <li>unscrew the knob (1) to allow the removal of the blade guard (2),</li> <li>remove the sharper (a)</li> <li>support the mask in plexiglass on the blade</li> <li>to coincide the axis of the two holes © on blade with two pins (d) on the mask by simply spinning the blade to the desired position,</li> <li>screw two knobs (e) without tighten excessively,</li> <li>loosen the three of four screws (f) that secure the blade,</li> <li>clean the blade, the surface opposite o the blade and the ring protection with the products, specified below,</li> <li>replace the group in reverse way.</li> </ol> 

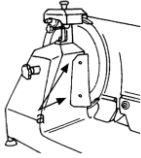
At end of each shift and before the daily use	Service person	<p><b>SLICE GUARD CLEANING</b></p> <ol style="list-style-type: none"> <li>1. switch off the machine and disconnect the feeding cable</li> <li>2. wear metal gloves</li> <li>3. unscrew two knobs (a) that block the slice guard,</li> <li>3. clean the guard with the products specified below,</li> <li>4. replace the guard in reverse way.</li> </ol> 
At the end of each shift and before the daily use	Operator	<p><b>GENERAL CLEANING:</b> All surfaces and the machine parts intended to come in contact with the food product, or <b>the food zones</b> (<u>blade cover, food platform, sail, etc...</u>) and <b>the splash zones</b> (machine external surface), must be cleaned and disinfected using the methods below</p> <p><b>Scrape the surfaces from the possible food product residuals</b> (for example with plastic scrapers);</p> <ul style="list-style-type: none"> <li>➤ <b>Clean all food zone and splash zone surfaces with a soft cloth dampened (not dripping) with detergent diluted in hot water</b> (also common hand dish detergent) .Use specific products for aluminum: they should be liquids (not cream or abrasive pastes) and above all must not contain chlorine. Against the fat use denaturated alcohol.</li> <li>➤ <b>Rinse with clean warm water and dry all surfaces</b> with a soft clean cloth that doesn't lose bristles.</li> <li>➤ <b><u>The aluminium parts cannot be washed in the dishwasher.</u></b></li> </ul> <p><b><u>DISINFECTION</u></b></p> <ul style="list-style-type: none"> <li>➤ Use detergents with not oxidizing neutral PH</li> <li>➤ If hot water (&gt; 60°C) is used, use only demineralized water</li> <li>➤ If other products are used, these last ones must be appropriate to the material type.</li> <li>➤ For machines with parts in aluminium it is possible to use products based on peracetic acid.</li> </ul> <p><b><u>PERIODS OF LONG INACTIVITY</u></b></p> <ul style="list-style-type: none"> <li>➤ During the long periods of inactivity, protect all the aluminium surfaces by wiping them with a cloth moisture with Vaseline oil. The oil firm protect the parts.</li> </ul> <p><b><u>THINGS NOT TO DO BEFORE OR DURING THE CLEANING:</u></b></p> <ul style="list-style-type: none"> <li>➤ Access to the moving parts <u>without having previously assessed for their stop;</u></li> <li>➤ Access to the moving parts without have <u>stopped it in guaranteed security</u> (switched to position zero and supply cable disconnected)</li> </ul> <p><b><u>PRODUCTS NOT TO USE:</u></b></p> <ul style="list-style-type: none"> <li>➤ <u>compressed air with jets towards the zones with deposits of flour in general towards the machine;</u></li> <li>➤ <u>stem devices;</u></li> <li>➤ <u>detergents containing CHLORINE (also if diluted) or compounds such as: the bleach, the acid muriatic , products for unclogging the drain, caustic soda, products for the marble cleaning, descaling in general etc. they can attack the composition of the aluminium, staining and oxidizing it permanently.</u></li> <li>➤ The sun exhalations of these products can oxidize and in some cases corrode aluminum.</li> <li>➤ <u>Steel wool, brushes or abrasive discs</u> produced with other metals or alloys (ex. Common steel, aluminum, brass, etc...) or tools that have previously cleaned other metals or alloys, which in addition scratch the surfaces;</li> <li>➤ <u>Detergents in abrasive powder;</u></li> <li>➤ <u>Gasoline, solvents or flammable and/or corrosive fluids;</u></li> <li>➤ <u>Substances used to clean the silver.</u></li> </ul>



## LUBRICATION



It is forbidden to lubricate with hand the organs and the elements in motion.

Lubrication can be done only and exclusively **after discharging the machine with the food being processed and having it isolated from the electrical power source.**

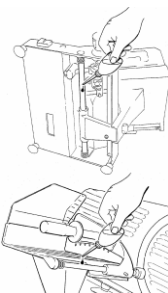
FREQUENCY	PERSONNEL	
Weekly	Operator	<p><b>TROLLEY SLIDING GUIDES AND PRODUCT PRESS SLIDING ROD</b></p> <ol style="list-style-type: none"> <li>switch off the machine and unplug the power cord,</li> <li>tilt the machine as shown in figure</li> <li>put a small quantity of oil on the rod and slide the group 3-4 times,</li> <li>clean as required to remove excess lubricant,</li> <li>lay the machine back on its legs</li> </ol> <p>Use only the oil provided; otherwise use white Vaseline oil. <b>NEVER USE USE VEGETABLE OILS.</b></p> 

## EXTRAORDINARY MAINTENANCE

For extraordinary maintenance and parts changes, resulting in cracks or revisions or mechanical or electrical failure **Contact Authorized Assistance Centre.**

The instructions for extraordinary maintenance, not mentioned in the present instructions manual for the use, must be explicitly requested from the seller (manufacturer); these interventions are:

- sharpener grindstones change
- tensioning or change of drive belt
- change of the electrical components
- structural repairs or replacement parts not specifically mentioned herein.

## **FAILURES IN MACHINE OPERATIONS**

The following failures can only be solved **by trained service personal**.

<b>TYPE</b>	<b>POTENTIAL CAUSES</b>	<b>ACTION AND CHECKS</b>
<b>Missing power</b>	General Black out  Fuses or magnetic thermal fuses placed upstream of the machine supply line	Contact the local electricity distributor  After having eliminated the causes that have determined the protection device intervention, reset it again. In case of problem persistence contact a qualified electrician.
<b>Functioning interruption</b>	Protection device intervention inside the machine  Not identifiable cause/s	Contact an electrician: after having eliminated the causes that have determined the protection device intervention, reset it. <b>In case of fuses intervention</b> , replace them with types of the same similar model, calibration curve and measures.  Contact directly the Authorized Assistance Centre
<b>The machine doesn't switch on</b>	Missing voltage.  Sectioning devices placed on "OFF".  Intervened fuses or not functioning magnetic thermals.  Lacked running button functioning	Verify that the plug is correctly inserted.  Turn the sectioning devices in the "ON" position  Change the intervened fuses, check the magnetic thermal switches condition.  Check the START button efficiency and eventually contact directly the Authorized Assistance Centre.
<b>The machine does not start and it can be heard a hum (only for three-phase machines)</b>	The motor functions with two phases or defect in the supply circuit of the machine	Stop the machine and call for service to check the electrical cable and the supply circuits control.
<b>The direction of rotation of the blade is incorrect (only for three phase machines)</b>	The supply cables are not properly connected .	Call the service to reconnect the two electrical cables.
<b>The machine starts but the indicating light doesn't switch on.</b>	Indicating light damaged or faulty	Contact directly the Authorized Service Center.
<b>The indicating light switches on but the machine doesn't start</b>	Electric card faulty or damaged	Contact directly the Authorized Service Center
<b>During operation, the machine vibrates, the motor overheated and there is a bad smell</b>	Defected motor	Contact directly the Authorized Service Center
<b>During the operation the blade rotation speed slows down or stops.</b>	Transmission group out of order or oil or other substances are blocking the transmission group	Contact directly the Authorized Service Center
The product is cut correctly and the discs are frayed or have not honed an uneven shape.	Blade not sharpened  Worn blade	Sharpen the blade  Contact directly the Authorized Service Center
<b>The blade sharpening isn't satisfactory</b>	Grindstones greased  Worn grindstones	Clean carefully the grindstones  Contact directly the Authorized Service Center
<b>The slide doesn't slide</b>	Sliding guides dirty and/or not lubricated	Clean and/or lubricate the grindstones
<b>Stop button doesn't work</b>	Electric circuit out of order	Stop the machine disconnecting the feeding plug and contact directly the Authorized Service Center

## 6. DISPOSAL OF THE MACHINE



The crossed container symbol on the machine shows that the product at the end of its useful life must be collected separately from other refusals



If we decide to not use ever the machine because it is obsolete, damaged or worn, its out of service must be entrusted to specialized and trained personnel. At the end of the dismantling activities all identification plates and other document must be destroyed. The machine can be sold without the possibility to reduce it in small pieces; it is sufficient to disconnect the main groups that compose it and to send them for the scrapping.

Don't sell the machine like mixed urban refusal, perform the waste separation.  
The machine collection or harvest systems are:

- Collection through distributor consortium
- Delivery possibility to the machine distributor equivalent to the purchasing certificate of a new machine.

In the machine there aren't dangerous substances with potentially negative effects on the ambient and on the human health. It is fundamental that the purchasers contribute to the reuse, to the recycling and to the other forms of machine restoring. It is the employer obligation to be aware of the actual laws of own country and work so to be comply with these legislations.



**It is forbidden and besides liable of penalties to leave the machine and the electric equipment in the nature.**

## 7. GUARANTEE

The machine is guaranteed 12 (twelve) months from the sale date.

The guarantee covers the machines reparations acquired c/o the authorized sale points, if it is demonstrated that they are faulty in the materials or in the assembly, to the conditions here follow described:

1. For guarantee gets on the free change of all parts that are resulted manufacturing defect. The guarantee decades if not coupled from fiscal ticket or invoice certifying the purchase and for the following cases:
  - a. Machine tampering or damaging due to negligence;
  - b. Machine use with non conformance modalities to the warnings described in the instructions handbook;
  - c. Damages caused from the non environment suitability in which the device works and from phenomenon not dependent from the machine normal functioning (voltage values irregularities and frequency in the net plant);
  - d. Reparations interventions performed from people or centers not authorized from the manufacturer,
2. The intervention request in guarantee will have to be performed only in the sale points or authorized laboratories;
3. The machine will have to be free port returned to the manufacturer for the reparation and the transportation expenses are always charged to the receiver,
4. It is excluded the machine change nor the guarantee prolongation following the intervention for damage;
5. The manufacturer doesn't answer for direct or indirect damages of any nature to people or things for the improper use of the machine or for lacked use during the time occurring for the reparations.

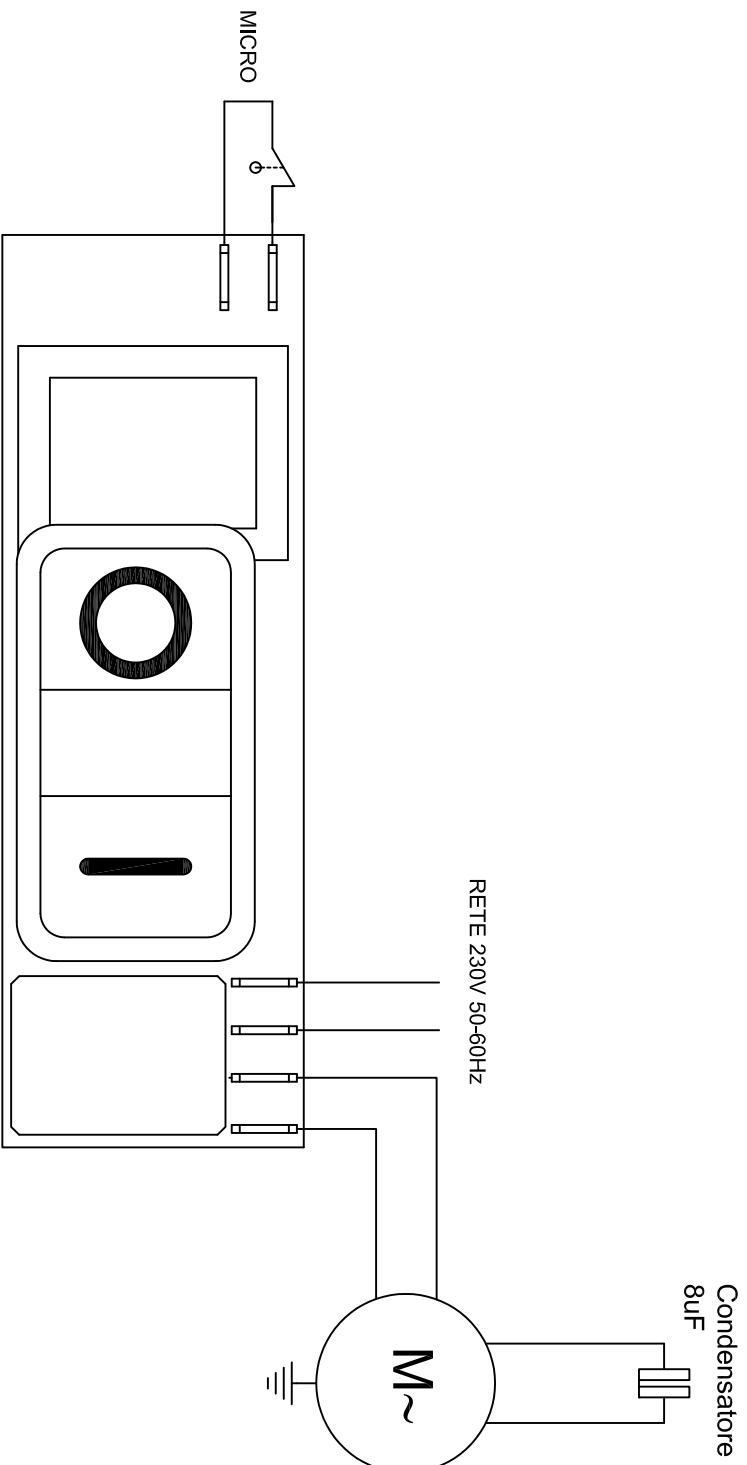

Scheda	MAB-896	Volt/Herz	230/50-60
Macchina	AFFETTATRICE GRAVITA' 250		
<b>FAVINA</b> <b>INDUSTRIE</b>	Disegnato	Andrea B.	
	Controllato	M. Pari	
	Data	07/07/2015	

DOCUMENTO RISERVATO AI TERMINI DI LEGGE E' VIETATO RIPRODURRE O DIVULGARE IL PRESENTE SENZA NOSTRA AUTORIZZAZIONE SCRITTA



**metos**  
kitchen intelligence®