

metos

DISHWASHER

Metos Master HOOD-110, HOOD-800

Instructions for Use and Maintenance

Manufacturers original documentation



COD.: 3050E - Ed. 09 - 09/2022

4552446, 4552446N, 4552445, 4552445N



Vi ringraziamo per aver acquistato un nostro apparecchio.

Le istruzioni per l'installazione e la manutenzione nonché il suo impiego, che troverete sulle pagine che seguono, sono state preparate per assicurare una lunga vita e un perfetto funzionamento del vostro apparecchio.

Seguite attentamente queste istruzioni.

Noi abbiamo ideato e costruito questo apparecchio secondo le ultime innovazioni tecnologiche. Voi ora dovrete averne cura.

La vostra soddisfazione sarà la nostra migliore ricompensa.

Thank you for choosing our machine.

The instructions for installation, maintenance and use found on the following pages have been prepared to ensure a long life and a perfect operation of your unit.

Please, do follow the instructions carefully.

We have designed and built this machine using the latest innovative technologies. Now you shall take good care of it.

Your full satisfaction is our greatest reward.

Nous vous remercions d'avoir choisi notre machine.

Les instructions pour l'installation, l'entretien et l'utilisation qui figure dans les pages suivantes ont été préparées pour assurer une longue durée de vie et un fonctionnement parfait de votre appareil.

S'il vous plaît, veuillez suivre attentivement les instructions.

Nous avons conçu cette machine, en utilisant les dernières technologies innovantes. Vous devrez maintenant en prendre soin.

Votre satisfaction est notre plus grande récompense.

Wir danken Ihnen für den Kauf dieses Gerätes.

Die Anleitungen zu Installation, Wartung und Betrieb des Gerätes, die Sie auf den folgenden Seiten finden, wurden erstellt, um Ihrem Gerät eine lange Lebensdauer und einen ordnungsgemäßen Betrieb zu gewähren.

Befolgen Sie diese Anweisungen aufmerksam.

Dieses Gerät wurde nach dem letzten Stand der Technik entwickelt und konstruiert. Diese Anleitung soll Ihnen dabei helfen, es gebührend zu pflegen.

Ihre Zufriedenheit ist für uns die beste Entlohnung.

Gracias por haber adquirido uno de nuestros productos.

Las instrucciones para la instalación y mantenimiento, así como su uso, que se encuentran en las páginas que siguen, se han preparado para asegurar una larga vida y un funcionamiento fiable de su unidad.

Sígalas atentamente.

La máquina ha sido proyectada y fabricada con las últimas innovaciones tecnológicas. Por favor, utilícela con cuidado.

Su satisfacción es nuestra mejor recompensa.

Благодарим Вас за выбор нашей продукции.

Инструкции по установке, использованию и обслуживанию, представленные в настоящем руководстве, были подготовлены для того, чтобы обеспечить долгую и исправную службу Вашего оборудования.

Пожалуйста, точно следуйте приведённым в руководстве указаниям и рекомендациям.

Мы разработали и изготовили это оборудование в соответствии с самыми последними техническими достижениями.

Теперь его судьба зависит от Вас.

Лучшая награда для нас - Ваше удовольствие от работы с нашим оборудованием.

Obrigado por adquirir um dos nossos aparelhos.

As instruções de instalação, manutenção e utilização que encontrará nas páginas seguintes foram preparadas para garantir uma longa duração e um perfeito funcionamento do seu aparelho.

Siga estas instruções escrupulosamente.

Idealizámos e construímos este aparelho segundo as últimas inovações tecnológicas. Agora, cabe-lhe a si cuidar dele.

A sua satisfação será a nossa melhor recompensa.

TRANSLATION OF THE ORIGINAL INSTRUCTIONS

Contents	Page
WARNINGS	4
1. MACHINE INSTALLATION	7
1.1 Dataplate	7
1.2 Reception of the appliance	8
1.3 Hydraulic connection	8
1.3.1 Water supply characteristics	9
1.4 Electrical connection	9
1.5 Steam evacuation	10
1.6 Positioning the machine	10
2. MACHINE DESCRIPTION	11
2.1 Machine description	11
2.2 Machine features	11
3. CONTROL PANEL AND RELATIVE SYMBOLS	12
4. OPERATION	13
4.1 Cutlery and crockery loading	14
4.2 Use of detergent	14
4.3 Use of rinse aid	15
4.4 Regeneration device (optional)	15
4.5 Drain pump system (optional)	16
4.6 Compliance with hygiene regulations and H.A.C.C.P.	16
4.7 Pressure increase pump (optional)	16
5. MAINTENANCE	17
5.1 Regular Maintenance	17
5.2 Special Maintenance	17
6. ALARMS	18
7. ENVIRONMENTAL ASPECTS	18
7.1 Packing	18
7.2 Disposal	18
8. ECOLOGICAL ASPECTS	19
8.1 Recommendations for optimum use of energy, water and additives	19
9. TROUBLESHOOTING	20

WARNINGS



This instruction booklet must be kept with the dishwasher for future consultation. If the dishwasher is sold or transferred to another user, make sure the booklet always goes with the appliance so that the new owner can have the necessary information on operation and the relative instructions.

The instruction booklet must be carefully read before installation and first use of the dishwasher.

The user must comply with the following rules:

- Adaptation of the electrical and water systems for dishwasher installation must only be carried out by qualified operators.
- This dishwasher must only be used by adults. This is a professional machine to be used by qualified personnel, and installed and repaired exclusively by a qualified technical assistance service. The Manufacturer declines any responsibility for improper use, maintenance or repair.
- This appliance can be used by trained youth aged from 15 years and above. It cannot be used by persons with reduced physical, sensory or mental capabilities or lack of experience and knowledge.
- Children shall not play with the appliance.
- Cleaning and user maintenance shall not be made by children without supervision.
- Accompany the hood in opening and closing.
- Servicing of this dishwasher must be performed by authorized personnel.

Note: Use original replacement parts only. Otherwise the product warranty is invalidated and the manufacturer is no longer responsible.

- **The dishwasher is designed only and solely for washing plates, glasses and various pots and pans with human food type of residue. DO NOT wash articles polluted with petrol, paint, bits of steel or iron, fragile objects or material not resistant to the washing process. Do not use acidic corrosive chemical products or alkaline and solvents or chlorine based detergents.**
- Make sure the dishwasher is not resting on the power cord or the filling and drain hoses. Level the machine by adjusting the support feet.

-
- Do not use the appliance or any part of it as a stepladder or means of support as it has been designed exclusively to bear the weight of the dishrack containing dishes to be washed.
 - Do not open the machine door when operating. In any case, the machine has a special safety device which immediately stops the unit if the door is open, thus preventing water spillage. Always switch the machine completely off and drain the water tank, before accessing inside.
 - **This machine must be disconnected from the main electrical supply after use at the end of the day and for any service/maintenance operation following this procedure:**
 - Switch the machine off from the control panel.**
 - Drain the tank by removing the overflow pipe.**
 - Disconnect the electrical supply by the omni-polar switch (main switch located on the wall).**
 - Shut the water supply valve(s).**
 - Disregarding the aforesaid prescriptions is a serious misuse and can cause damages and injures to property and people, and will relieve the manufacturer from whatever liability.**
 - Do not use old load pipe, but only new ones.
 - The user must not carry out any repair and/or maintenance operations. In any case contact qualified personnel.
 - Do not put material or objects on the machine.
 - Some important rules must be followed for using this appliance:
 - Never touch the appliance with wet hands or feet
 - Never use the appliance when barefoot
 - Do not install the appliance in places exposed to water sprays.
 - The water used for the washing and the rinsing is not potable because of the presence of chemical additives. In case of contact with skin or eyes wash them immediately with plenty of water and check the safety instructions of the detergent manufacturer. If necessary, contact a doctor.
 - Do not dip bare hands into water containing detergent. If this should occur, wash them immediately with plenty of water.
 - Only follow the instructions given in the manufacturer's booklet for cleaning operations (see chap. **5. MAINTENANCE**).
 - The machine has an IP (see serial number label on the machine) protection rating against accidental water splashes and is not protected against pressurized water jets. Pressure-cleaning systems shall, therefore, not be used on this machine.

-
-
- This appliance is designed to work at room temperatures from 5 °C up to a max. 35 °C, in a suitable room.
 - Do not use water to extinguish fires on electrical parts.
 - Do not cover the intake or dissipation grids.
 - Water infeed to the machine 400 kPa maximum.

Note: The manufacturer declines any responsibility for accidents to people or any damage deriving from failure to observe the above listed instructions.



ATTENTION: DO NOT INSERT HANDS AND/OR TOUCH THE PARTS LOCATED AT THE BOTTOM OF THE WASH TANK AND/OR AT THE END OF THE WASH CYCLE.



ATTENTION: INTERNAL CLEANING OF THE MACHINE SHALL BE CARRIED OUT AT LEAST 10 MINUTES AFTER THE POWER SWITCH HAS BEEN TURNED OFF.

1. MACHINE INSTALLATION

1.1 Dataplate

- A Power source
- B Total power installed
- C Dynamic Pressure
- D Envelope protection degree
- E Total electricity absorption

Model Family		DWXXXX		IPXX	
Model Code		DESCRIPTION			
S/N	DWX10XXXXX	Type			
	400V 3N 50HZ	xxA			
	xxxxW				
	MAX	xxx-xxx kPa			
	MAX	xx°C			
	MAX	xx°C			
	MAX	xxkPa			
					MADE IN ITALY YYYY
Model		S/N			

Model DW XXXX

FAMIGLIA PRODOTTO
FAMILY PRODUCT
FAMILLE DU PRODUIT
FAMILIA PRODUCTO
FAMILIE DES PRODUKTES
СЕРИЯ ПРОДКТА

S/N DW X xxxxxxxx

ANNO N=2017 - 2018
YEAR O=2018 - 2019
ANNÉE P=2019 - 2020
AÑO Q=xxxx - xxxx
JAHR
ГОД ВЫПУСКА

NUMERO DI SERIE
SERIAL NUMBER
NUMÉRO DI SÉRIE
NUMERO DI SERIE
SERIENNUMMER
СЕРИЙНЫЙ НОМЕР

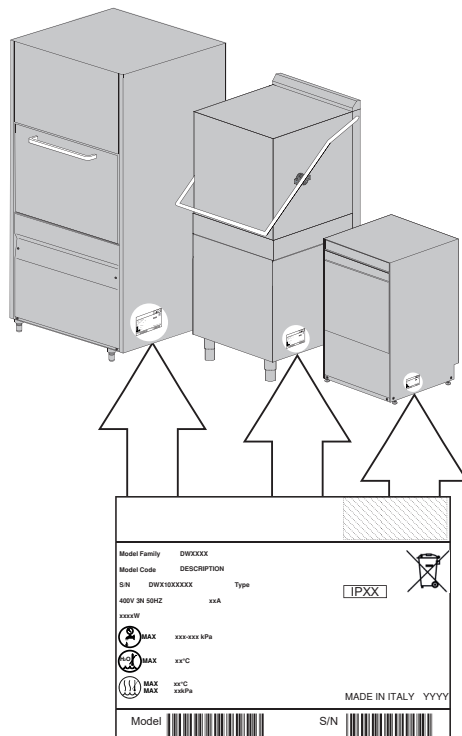

1.2 Reception of the appliance

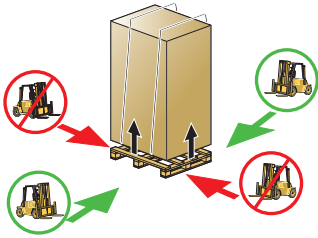

Before accepting the machine, verify that all the data on the data-plate corresponds to the required ones and to the ones of the available electrical supply (see paragr. **1.1 Dataplate**).

After unpacking, make sure the machine has not been damaged during transportation. If so, do notify the seller immediately about the problem. If the damage might question the machine safety, do not install it.

The installation and the starting of the machine must be carried out by trained operators only, even if the machine is coming from another site and it has been used, already.

For disposal of the packing see chap. **7. ENVIRONMENTAL ASPECTS**.

1.3 Hydraulic connection

Connect the machine's water supply with an interrupt valve capable of quickly and completely shutting off water intake. Make sure that the water supply pressure comes within the values given in the table Tab. 1. If it is less than 2 bar dynamic pressure (200 kPa) a pressure pump **must be installed** to guarantee optimal machine operation (by request, the dishwasher can be supplied with a pump). If, however, the water supply pressure is greater than 4 bar (400 kPa), a pressure reducing device **must be installed**.

For water with average hardness greater than 8 °f, a water softener **must be used**. This will result in cleaner dishes and longer life of the appliance. By request, the machine can be equipped with a water softener

If the machine is equipped with a water-softener, a regeneration of the resins shall be done on regular basis (see paragr. **4.4 Regeneration device**). In machines equipped with optional **regeneration device** it is advisable to use water at a temperature not above 40 °C, so as not to alter the characteristics of the resins.

Note: Any damage caused by limestone (calcareous water higher-up than 8 °f and without water-softener) will not be covered by warranty.

In order to ensure the optimum performance, the water supply temperature must come within the range given in table Tab. 1.

Each machine is provided with a rubber tube with a 3/4" threaded attachment for water filling. It is advisable to connect the hose to a water supply not above 60 °C, if connected to the hot water.

Machines shall be made with extra power in case of cold water infeed.

Connect the emptying tube, supplied with the appliance, to the union elbow located under the tub so that water flows freely. If it is not possible to empty the water at a level lower than the drain of the appliance, it is advisable to install an emptying pump, which can be provided by request.

The emptying tube should always be connected to a siphon to prevent odor back-up from the screen.

Water characteristics table	Min	Max
Static Pressure	200 kPa	400 kPa
Dynamic Pressure	150 kPa	350 kPa
Water hardness	2 °f	8 °f
Cold water-supply temperature	5 °C	50 °C
Hot water-supply temperature	50 °C	60 °C
Capacity	10 l/min	

Tab. 1

1.3.1 Water supply characteristics

The machine water supply must be potable, in compliance with the legislation in force. The inlet water must also meet the parameters given in the table Tab. 1.

Water parameters table	Min	Max
Chlorine ¹		2 mg/l
pH	6,5 ¹	8,5 ³
Water hardness		8 °f ²⁻³
Iron ³		0,2 mg/l
Manganese ⁴		0,05 mg/l

Tab. 2

¹ Out of range values might lead to corrosion and jeopardize the life of the machine.

² Should the water hardness is higher **it is compulsory** to install a water softener and check periodically its operation.

³ Out of range values might lead scaling and sediments with a consequent lower performance, functionality, and expected life of the machine.

⁴ 4 Desired value: Out of range values might lead stainless steel blackening/tarnishing.

It is recommended a water test once a year.

1.4 Electrical connection

Electrical connection must be carried out in compliance with the legislation in force and the relevant technical standards. Make sure that the voltage is the same as reported on the data-plate.

It is necessary to install a suitable omni-polar automatic fuse switch sized according to the absorption that assures the complete disconnection from the network in an overvoltage category III condition.

This switch must be incorporated in the supply network, dedicated only and exclusively to this circuit and installed in the immediate vicinity.

The machine has to be absolutely turned off by this switch: only this switch gives the full warranty of complete detachment from the electric network.

Make sure the appliance is linked to an efficient ground connection.



ATTENTION: Check very carefully if the “ground connection” of the machine is properly sized and fully efficient, and that not too many units are connected to it. An undersized or poor “ground connection” might lead to corrosion and/or pitting effect on the stainless steel plates, even to perforation.

The machine is also provided with a terminal (marked with the symbol ) placed laterally. It shall be used to bond different appliances via the external bonding conductor, in order to avoid the risk of electric shock.

The special dataplate gives the max. power value in watts (W) and amperes (A), for dimensioning of the line, cable and switches.

Note: For machines with 400Vac3N, H05RN-F or H07RN-F type cables must be used, or replace them with others if different from the standards in the Country where the dishwasher is installed. The dealer/importer/installer must adapt the power cable insulation class according to the work environment, in conformity with current Technical Standards.

WARNING: Some versions of this machine can dissipate more than 10 mA to earth.

The machine's sound level is $L_{pa} = 70\text{dBA} \pm 2.5$. **

**test made according to EN 60335-2-58/A11



Feed cable: The retailer - importer - installer must ensure that the feed cable complies with the cable insulation category of the workplace, in conformity with current Technical Standards.

1.5 Steam evacuation

In accordance with regulations of environmental hygiene, for the proper functioning of the machine and a healthy environment for the operator who working in there, it should be at least 10 air volume changes per hour in the room where the machine is installed.

For small wash rooms we recommend at least 15 air volume changes per hour.

1.6 Positioning the machine

Remove the packing with care.

Lift the machine as described in chap. **1.2 Reception of the appliance.**

Position the machine as shown on the installation diagram (lay-out) approved at the time of the offer.

Maintain a minimum distance of about 50 mm from the walls, so that motors are ventilated (see **Pict. 1**).

Install suction hoods to assure proper ventilation of the room, in order to eliminate steam and excessive humidity.

Check that the machine is properly levelled, by adjusting the legs (see **Pict. 2**).

Make sure the machine is not standing on the power cable or on the filling/drain hoses. Level the machine by adjusting the support feet.

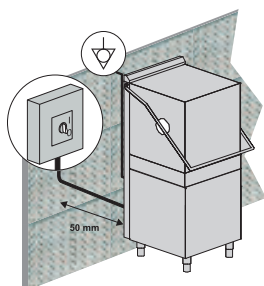

Pict. 1

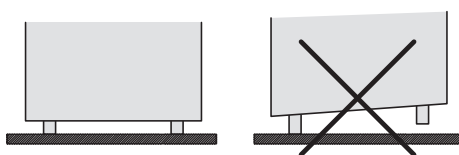

Pict. 2

2. MACHINE DESCRIPTION

2.1 Machine description

Wall-hung main power switch:
at installation
serviceman supply and
care, according to local
laws

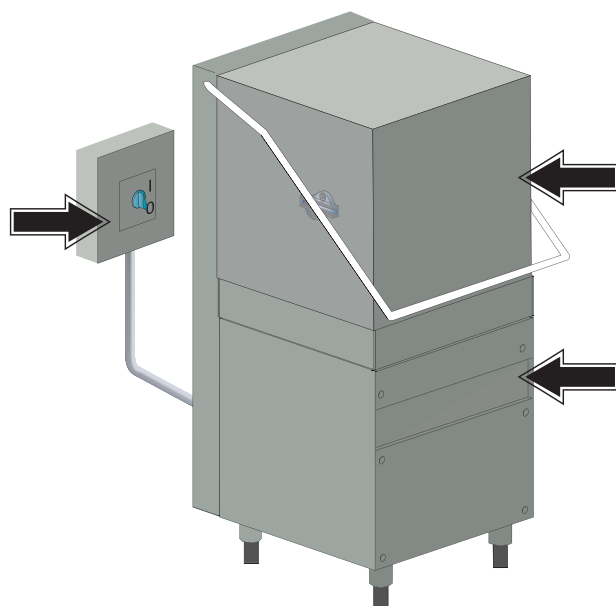

Hood

Control panel

Standard equipment for machine with a 500 mm rack:

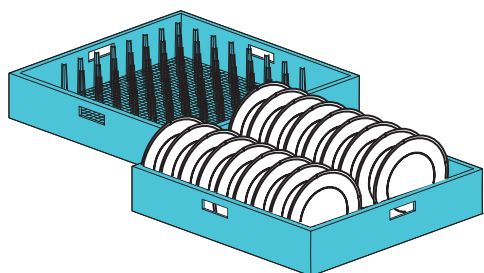

nr. 2 500x500 mm plates rack
Capacity per plate rack:
12 soup plates or
18 flat plates
Max Ø 410 mm

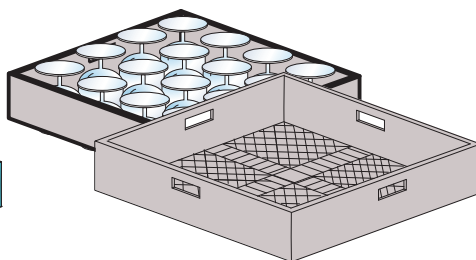

nr. 1 500x500 mm glasses rack

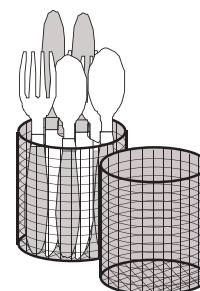

nr. 1 cutlery basket

OPTIONAL:

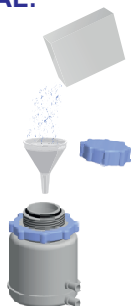

Water softener

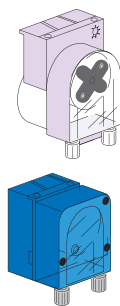

Detergent dispenser

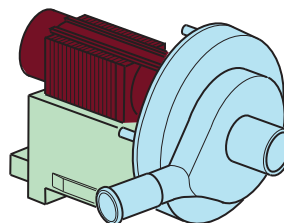

Drain pump





2.2 Machine features

The machine's sound level is $L_{pa} = 70\text{dBA} \pm 2.5$. **





**test made according to EN 60335-2-58/A11

3. CONTROL PANEL AND RELATIVE SYMBOLS

CONTROLS

-  2) Main switch 0-1
-  3) Wash type selector
-  4) Drain pump button
(if installed)
-  5) Regeneration START button
(if installed)

INDICATORS

-  F3) Washing cycle indicator
-  F4) Regeneration cycle indicator
-  F6) Boiler thermometer
-  F7) Tank thermometer

4. OPERATION

- Insert the overflow tube in the special seat inside the tub.
- Make sure all the filters are properly fitted in their seats.
- The filters must be cleaned every 40-50 wash cycles and whenever necessary.
- **Do not operate the machine without filters, and in particular the pump suction filters.**
- Open the water tap and plug in the main switch.
- Turn switch **0-1** to position **1** (pressed).
- Insert the special rinse aid dispenser tube in the liquid container and check that the quantity of additive is sufficient for daily use (see paragr. **4.3 Use of rinse aid**).
- Using the handle, lower the machine hood and the tank filling phase automatically starts.
- Should the machines be equipped with the WRAS certified Break Tank, the tank filling phase is extended.
- Then the heating phase begins.
- The machine will be ready for washing only when the boiler thermometer **F6** and tank thermometer **F7** indicate that the required temperatures have been reached, which are 80-85 °C for boiler and 50-55 °C for the tank.
- Before starting the wash-cycle, in absence of an automatic dosing system, pour the detergent in the wash-tank.
- Select the wash time with the selector **3**.
- Position 1 = short
- Position 2 = long
- Insert the basket with dishes or various articles to be washed and close the hood. The plates must be correctly placed in the rack (see paragr. **4.1 Cutlery and crockery loading**).
- The wash cycle starts automatically, immediately followed by the rinse cycle. The beginning of the cycle is indicated either by the light on the button itself or on the **F3** lamp.
- The **F3** lamp will turn off when the cycle is finished
- The appliance is ready for another cycle.

Note: It is advisable to change the tank water, by means of another filling, at least every 40-50 washes or twice a day.

- At the end of the day, clean the machine (see chap. **5. MAINTENANCE**).
- Turn off the machine and the water tap.
- Turn off the main wall switch.

4.1 Cutlery and crockery loading

Before cutlery and crockery loading in the machine, coarsely clean them from the leftover food. It isn't necessary to rinse the cutlery and crockery under water.



WARNING: Do not wash articles polluted with petrol, paint, chips of steel or iron, ash, sand, wax, lubricant grease. These substances damage the machine. Do not wash fragile objects or material not resistant to the washing process.

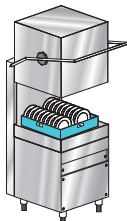
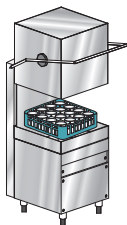

Note the following recommendations:

- Crockery and cutlery should not be inserted inside one another, covering each other.
- Place the crockery in order to all surfaces can be reached by water; otherwise the dishes are not washed.
- Make sure all the crockery are in a stable position and that the hollow containers don't overturn (cups, glasses, bowls, etc.).
- Place in the rack all the hollow containers such as cups, glass, etc. **upside-down**.
- Place the crockery with deep hollow with upper face downwards, so that water can flow out.
- Make sure the smaller crockery do not fall from the rack.
- Check all the wash arms runs freely and they are not blocked by too tall or too prominent crockery. Eventually, run a manual rotation of the arms to check it.

Pict. 3

Some foods, such as carrots, tomatoes, and others, may contain some natural dyes substances, that in large amounts, can alter the crockery and plastic parts colors.

Any discoloration does not mean that the plastic is not heat resistant.

Crockery and cutlery not suitable for dishwasher

Not suitable for dishwasher:

- Wooden crockery and cutlery or with wooden parts; water at high temperature causes deformation to wood. Also the adhesives used are not suitable for treatment in the dishwasher; a consequence could be the handles detachment.
- Crafts, precious vases or decorated glasses.
- Not heat-resistant plastic crockery.
- Copper, brass, pewter or aluminum objects: they may become discolored or opaque.
- The decorations on glass, after a certain number of washes, can lose gloss.
- Fragile glasses or crystal items, if often washed, can become opaque.

We recommend to buy exclusively crockery and cutlery suitable for dishwashing.

After several washes, the glass can become opaque.

It is mandatory to repeat the washing cycle if at the end of the cycle the crockery are not well clean or if there are washing residues (glasses, cups, bowls, etc. with liquid inside).

4.2 Use of detergent

By request the dishwasher can be equipped with an electric detergent dispenser (always recommended). If provided, the machine will automatically take the needed detergent amount.

The detergent must be of good quality, of NON-FOAMING type, specific for the mechanical washing of dishes.

The use of liquid detergents is recommended.

The dosing has to be done following the recommendations of the detergent manufacturer and in accordance with the water and dishes characteristics.

The detergent has to be inserted only in the wash tank. 1cm of the detergent drawn into the tube is equal to about 0,15 g. A correct amount of detergent is very important for a successful wash.

Note: It is forbidden to use detergents with chlorine-based reagents.

4.3 Use of rinse aid

It is possible to use the rinse aid to get quicker drying and polishing.

The machine is equipped with a rinse aid dispenser. The machine automatically draws the rinse aid chemical.

The dosing has to be done following the recommendations of the rinse aid manufacturer and in accordance with the water characteristics.

Note: Too much chemicals produces foam that reduces the effectiveness and lifetime of the washing pumps.

Too much chemicals might leave residuals on the dishes.

4.4 Regeneration device (optional)

Resin regeneration by the water softener is very important.

Resin regeneration: Resin regeneration should be carried out according to the number of cycles as indicated in the picture below Ex.: 27 °f (or 15 °d) = 39 cycles.

To carry out the purifying cycle, follow these instructions:

- Open the water tap and plug in the main switch.
- Turn the main switch **2** to 1 (ON) (see chap. **3. CONTROL PANEL AND RELATIVE SYMBOLS**).
- Lift the hood.
- Remove the overflow tube and empty all the water in the tub.
- Once the tank is empty check and fully replenish the salt, being careful not to spill it on the tank itself. A strong concentration of salt can negatively affect the correct functioning and service life of the machine. Fill the special container, placed on the inside of the tub, with coarse salt (1-2 mm. grains - the maximum capacity of the bowl is 500 g. - see **Pict. 4**).
- Close the hood, press button **5** for 5 seconds and wait for the cycle indicator **F4** to light up (see chap. **3. CONTROL PANEL AND RELATIVE SYMBOLS**). The resins contained in the water softener will be automatically regenerated in about 20 minutes. The cycle is completed when the indicator light **F4** goes off.
- After the softening cycle, switch the machine OFF (button **2** - see chap. **3. CONTROL PANEL AND RELATIVE SYMBOLS**).
- Turn off the main wall switch.

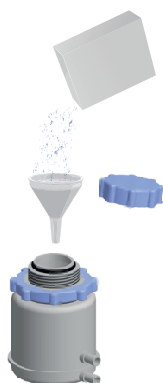

Pict. 4

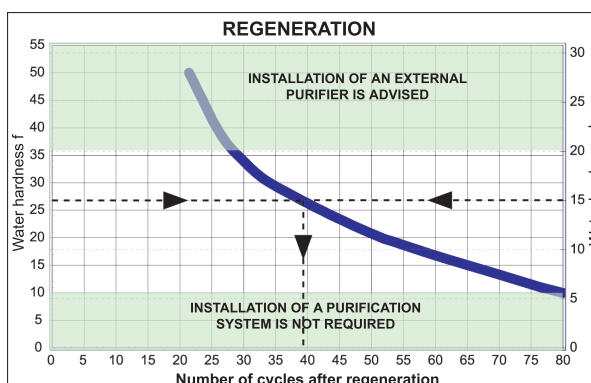

Note: Once the cycle has begun it cannot be stopped.

If a water conditioner is installed externally, follow the instructions given in the relative manual to regenerate the resins.

The flashing of the cycle lamp during the softening cycle, indicates a malfunction or a missed draining of the wash-tank (see chap. **ALARMS**).



WARNING: In the case of water hardness above 35 °f it is advisable to install an external water softener

4.5 Drain pump system (optional)

To empty the tank: remove the overflow and leave the hood open, then press the key **4** to start the automatic total emptying time (see chap. **3. CONTROL PANEL AND RELATIVE SYMBOLS**).

After emptying, the machine goes on standby.

At the end of emptying, turn off the switch **2** and the main wall switch.

If emptying does not occur in the set time, the cycle indicator **F3** flashes, indicating that emptying did not occur (check the pump filters and insertion of the overflow).

For another load, switch the machine off, insert the overflow and switch the machine on again.

During the wash-rinse cycle the water in excess is automatically drained.

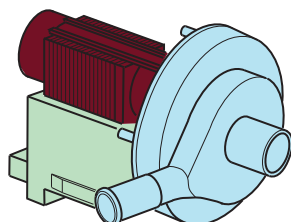

Pict. 5

4.6 Compliance with hygiene regulations and H.A.C.C.P.

- When starting the machine ON, no wash-cycle will be starting until the set boiler and wash-tank temperatures are reached. During operation, the machine will not start the rinse cycle till the set boiler temperature is reached.
- The machines are equipped with a temperature indicator **F5** which lights up when the boiler and the tub have reached the preset temperature (see chap. **3. CONTROL PANEL AND RELATIVE SYMBOLS** - values set by the manufacturer). It is recommended to wait for this light to go on before starting the next cycle.
- Scrape food from the dishes carefully in order not to clog the filters, nozzles and pipes.
- Unload the wash tub and clean the filters at least twice a day.
- Check that the amount of detergent and rinse aid dispensed is correct (as suggested by the supplier of the product). In the morning, before starting the machine, check that the quantity of chemicals in the canisters is enough for daily supply.
- Always clean the support floor of the dishes.
- Extract the rack with clean hands or gloves to avoid finger marks.
- Do not dry or polish the dishes with non-sterilized cloths, brushes, or dusters.

4.7 Pressure increase pump (optional)

The machine can be supplied with the pressure increase pump.

After periods of machine inactivity, make sure the supplementary pressure increase pump rotates freely. To do this, operate using a screwdriver in the special slot on the ventilating side of the motor shaft (see Pict. 6).

In case of blocking, move the motor shaft, inserting the screwdriver in the notch, turning it clockwise and anticlockwise.

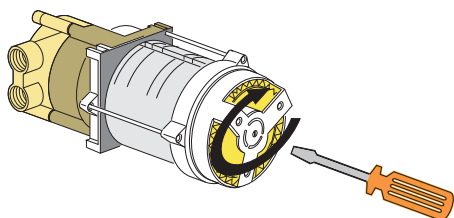

Pict. 6



5. MAINTENANCE



WARNING: The machine is not protected against water jets, therefore do not use pressure cleaning systems. Contact your cleaning products retailer for detailed instructions on the methods and products to use for periodic sanitizing of your appliance. **DO NOT** use bleach or chlorine-based detergents for cleaning the appliance.

5.1 Regular Maintenance

In order to ensure perfect performance, the appliance must be completely cleaned at least once a day in the following way::

- Turn the switch to 0 (see chap. **3. CONTROL PANEL AND RELATIVE SYMBOLS**).
- Turn off the main wall switch.
- Turn off the water tap.
- Remove the overflow tube to empty the water. For appliances provided with emptying pump follow the indications as described on paragraph **4.5 Drain pump system**.
- Remove the filters and clean them with a brush under a strong jet of water.
- Remove the rotors by loosening the fixing screws, and thoroughly clean the nozzles and cleaning and rinsing arms under running water
- Clean the tub thoroughly using specific products.
- Refit all the parts and arrange the impellers in their seats, securing them with the relative fixing screw. Take extreme care to re-assemble the nozzles in the right position (open and / or closed nozzles) and that the arms are installed with the right axial angle.
- At the end of the day, it is advisable to leave the dishwasher door open.



Note: It is advisable to change the tank water, by new filling, at least every 40-50 washes or twice a day. Do not use metal brushes or corrosive products which can damage the machine.

5.2 Special Maintenance

Once or twice a year have a **qualified technician** inspect the machine:

- 1** Clean the electrovalve filter.
- 2** To remove residual deposits.
- 3** To check the watertight of the seals for water loading and unloading connections.
- 4** Check the perfect state and/or wear of the components. If a component is damaged or oxidized replace it immediately, with genuine spare parts only.
- 5** Check the efficiency of the dispensers
- 6** Check the efficiency of the door safety switch.
- 7** Tighten firmly all electrical connections.



Pay attention to do not wet the motor or any electric part.

Perform maintenance with the wall-mounted main switch turned OFF.

Every 3-4 years of machine use, double-check the tightening and the efficiency of all electrical contacts, with special attention to the contacts of starters and relays.

Increase controls frequency if the machine is operating in heavy or intensive conditions.



6. ALARMS

Alarms will be displayed by the lighting of LEDs. according to their typology.

TYPE OF ALARM	CAUSE	REMEDIES
Flashing of the cycle lamp	Missed refill of water in the wash-tank	Verify the full opening of the water inlet valve Verify the right positioning of the overflow pipe Switch the machine OFF and ON to reset the alarm
	BOILER NOT HEATED	Boiler thermostat out of order. Check them or call for Service Boiler heating element out of order. Check them or call for Service
Flashing of the softening lamp	TANK DRAINING FAILURE	remove the overflow pipe and drain the tank. Switch the machine OFF and ON to reset the alarm

7. ENVIRONMENTAL ASPECTS



7.1 Packing

The packing consists of the following:

- a wood pallet;
- a nylon bag (LDPE);
- multi-layered cardboard;
- polystyrene foam (PS);
- polypropylene support (PP).

All above materials, shall be disposed and treated in accordance with the Local Laws in force.



7.2 Disposal

The equipment is marked with the symbol (see Pict. 7).

The symbol indicates that the product should not be discarded as unsorted waste but must be sent to separate collection facilities for recovery and recycling in compliance with the legislation in force.

Pict. 7

An efficient waste disposal procedure contributes to avoiding any potential environmental or health hazards as well as promoting the recycling and re-utilization of materials from which our appliances are constructed.

If the user does not comply with the regulations he/she shall be subject to the penalties foreseen by each member state.

Disconnect electricity and water before disposal.

Cut the electrical cable to ensure that further use is impossible.

All metal parts are recyclable as they are made of stainless steel.

Recyclable plastic parts are marked with the plastic material symbol.



8. ECOLOGICAL ASPECTS

8.1 Recommendations for optimum use of energy, water and additives

Dispensing of salt: A pre-set quantity (by the manufacturer) of salt is injected in the resins every regeneration cycle. It is important to observe the number of regeneration cycles recommended in paragraph **4.4 Regeneration device** in order to avoid salt spills or lime deposits..

If possible, use the machine at full load: This will avoid wasting detergent, rinse aid, water and energy.

Detergents and rinse aids: Use detergents and rinse aids having the highest biodegradability so that the environment is better respected. Have the correct dosage according to the water hardness checked at least once a year. An excess of product pollutes rivers and seas, whereas an insufficient amount compromises dish washing and/or hygiene.

Tank and boiler temperatures: The temperatures of the tank and boiler are set by the manufacturer so as to get the best washing results with the majority of detergents on the market. These can be reset by the installer according to the detergent used. (see paragr. **Temperature adjustment**).

Cleaning off: Carefully clean off the kitchenware using water at ambient temperature with moderation so as to make removal of animal fats easier. To remove encrusted matter, soaking in hot water is recommended.

Notes: Wash the objects as soon as possible in order to prevent the deposits from drying and jeopardizing the effectiveness of the washing.

To get an efficient wash, it is advisable to regularly clean and maintain the dishwasher (see chap. **5. MAINTENANCE**).

Non-compliance with the above recommendations or with any and all information within the manual could result in a waste of energy, water, and detergent, further causing an increase in user costs and/or a reduction in performance.



9. TROUBLESHOOTING

Type of Problem	Possible Causes	Cure
The appliance does not start	The main switch is turned off	Turn on the switch
The appliance does not draw water	The water tap is closed	Open the water tap
	The rinsing arm nozzles or the electrovalve filter are clogged and/or caked with lime deposits	Clean the rinsing arm nozzles, the pipes and the electrovalve filter. If the machine has a water softener check the salt content or regenerate the resins more often
	Faulty pressure switch	Replace the pressure switch (call the Technical Assistance service)
Flashing of the cycle lamp	See chapter ALARMS	---
The machine loads water very slowly	Scarce water supply pressure	Check the water supply pressure
	Rinse booster pump blocked (if installed)	Call the Technical Assistance service
Unsatisfactory washing results	The washing nozzles are clogged or the washing arms do not rotate	Unscrew and clean the nozzles and the rotating column, refit them correctly in their seats
	Unremoved grease or starch	Detergent concentration too low
	The filters are too dirty	Remove and clean the filters with a brush under a jet of water then refit them in their seats
	Check tank temperature (which must be between 50 °C and 60 °C).	Adjust the thermostat or check correct heating element operation
	Length of washing cycle inadequate for type of grime build-up	Choose a longer cycle if possible, otherwise repeat wash cycle
	Wash water too dirty	Empty water from the tub, clean filters; refill the tub and correctly reposition the filters
Presence of foam	Use of unsuitable products	Use no-foam detergents or reduce the dose in use.
	Tub temperature too low	Adjust the thermostat or check correct heating element operation
The objects are not dried properly	Insufficient rinse aid	Increase the amount of rinse aid by turning the screw on the dispenser (see paragraph Rinse aid dispenser)
	The rack is not suitable for the objects.	Use the suitable rack which gives the objects an inclined position so that water can rinse away.
	The washed items may have been sitting in the wash chamber too long.	As soon as the cycle stops, remove the rack with the objects so that they can dry more quickly in the air.
	Rinse water temperature is less than 75 °C - 80 °C	Check the temperature of the boiler thermostat
	Surface of objects too rough or porous for material wear	Replace type of dishes and glasses used

Type of Problem	Possible Causes	Cure
Streaks or smears on the objects	Too much rinse aid	Decrease the amount of rinse aid by turning the fine-adjustment screw on the dispenser (see paragraph Rinse aid dispenser)
	The water is too hard	Check the water quality. Water must not exceed 8 °f (5 °d) in hardness
	For appliances with conditioners: too little salt in the salt container or the resins have not been properly regenerated	Fill the salt container (coarse salt: 1-2 mm grains) and regenerate the resins more often. If lime deposits are also observed on the body of the machine, have a qualified technician check the operation of the water softener
	Salt present in dishwasher tub	Thoroughly clean and rinse the appliance, and avoid spilling salt when filling the container
The appliance suddenly stops during the cycle	The appliance is connected to an overloaded circuit	Connect the appliance separately (call the Technical Assistance service)
	A safety device has been activated	Check safety devices (call the Technical Assistance service)
During wash cycle the machine stops and draws water	Water from the previous day has not been replaced	Empty the tub and refill it
	The tub water temperature is too high	Have the Technical Assistance service check the thermostat and the pressure switch
	Faulty pressure switch	
minutes-> Min, day-> day, month-> Mon, year-> year).	The overflow tube is incorrectly positioned	Remove the overflow tube and correctly reposition it
	Little pressure on feeding	Take out the boiler pipe and drain the pump
The washing pump doesn't work	The pump is blocked	Call the Technical Assistance service

**Note: For any other problems, contact the Technical Assistance service.
The manufacturer reserves the right to alter the technical characteristics without prior notice.**



Metos Oy Ab

Ahjonkaarre, FI-04220 Kerava, Finland

Tel. +358 204 3913

e-mail: metos.finland@metos.com

www.metos.com