USER MANUAL

Cold Plate

Installation Variants: plug in

Cold Plate EC GN1

Cold Plate EC GN2

Cold Plate EC GN3

Cold Plate EC GN4

Remote Cooling System

Cold Plate – Z EC GN1

Cold Plate – Z EC GN2

Cold Plate – Z EC GN3

Cold Plate – Z EC GN4

On Counter Variants

Cold Plate – A EC GN1

Cold Plate – A EC GN2

Cold Plate – A EC GN3



E

Keep the manual handy with the device!

1. GENERAL.....	4
1.1 INFORMATION ABOUT THE USER MANUAL	4
1.2 LIABILITY AND WARRANTY	4
1.3 COPYRIGHT	4
1.4 DECLARATION OF CONFORMITY	5
2. SAFETY.....	6
2.1 GENERAL	6
2.2 SAFETY INSTRUCTIONS FOR USE OF THE DEVICE	6
2.3 INTENDED USE.....	7
2.4 SAFETY INSTRUCTIONS FOR DEVICES WITH REFRIGERANT ISOBUTANE R600A.....	8
3. TRANSPORT, PACKAGING AND STORAGE.....	9
3.1 TRANSPORT INSPECTION	9
3.2 PACKAGING.....	9
3.3 STORAGE	9
4. TECHNICAL DATA	10
4.1 TECHNICAL SPECIFICATIONS.....	10
4.2 PRODUCT DIAGRAM	11
4.2.1 <i>Installation Variant – plug-in (diagram size GN1)</i>	11
4.2.2 <i>Installation Variant – Remote Cooling System (diagram size GN1)</i>	11
4.2.3 <i>On Counter - (diagram size GN1)</i>	12
4.3 SCOPE OF SUPPLY.....	12
4.4 LABELING.....	13
4.5 PICTOGRAMS.....	13
5. INSTALLATION AND OPERATION.....	14
5.1 SAFETY INFORMATION	14
5.2 INSTALLATION AND ELECTRIC CONNECTION	15
5.2.1 <i>Installation (only valid for installation variants)</i>	15
5.2.2 <i>Electrical connections</i>	16
5.3 OPERATION.....	16
5.3.1 <i>Control panel</i>	16
6. CLEANING AND MAINTENANCE	18

6.1 SAFETY INSTRUCTIONS FOR CLEANING	18
6.2 CLEANING	18
6.3 SAFETY INSTRUCTIONS FOR MAINTENANCE	18
6.4 MAINTENANCE	19
7. POSSIBLE MALFUNCTIONS	20
8. DISPOSAL.....	21
9. CONFORMANCE DECLARATION	22

1. GENERAL

1.1 Information about the user manual

This user manual describes the installation, operation and maintenance of the device and serves as an important source of information and reference.

The knowledge of all safety and handling instructions contained in the user manual creates the conditions for the safe and proper operation of this device.

In addition, you must comply with all relevant local accident prevention regulations and safety regulations concerning the permitted uses of the device.

The user manual is part of the product and must be accessible at all times in the immediate vicinity of the device for the installation, operation, maintenance and cleaning staff.

1.2 Liability and Warranty

All information and instructions in this user manual have been compiled in accordance with current regulations, the current state of engineering technology and our many years of knowledge and experience.

The actual scope of delivery may differ for special designs, utilization of additional order options or due to the latest technical changes to the explanations and representations described herein. In case of questions, please contact the manufacturer.



NOTE!

This user manual should be read carefully before starting work on and with the device, in particular before commissioning! The manufacturer accepts no liability for damage and faults that arise from non-compliance with the operating instructions.

The user manual must be kept directly on the device and accessible to all persons working on or with the device. We reserve the right to make technical changes to the product in the context of improving the usage properties and further development. Our current user manual can be downloaded online from our homepage.

1.3 Copyright

The user manual, including any text, drawings, images and other depictions, is protected by copyright. Reproduction in any manner and form - including excerpts - as well as the utilization and/or communication of the content is forbidden without permission in writing from the manufacturer. Any non-compliance is liable for damages. All other rights are reserved.



NOTE!

The graphical representations in this user manual may differ slightly from the actual design of the device.

1.4 Declaration of Conformity

The device corresponds to the latest standards and EU directives.

We certify this in the CE Declaration of Conformity.

The Declaration of Conformity can be found in this user manual under section 9.

2. SAFETY

This section provides an overview of all-important safety aspects.

In addition, each chapter provides precise safety instructions for the prevention of dangers which are marked with symbols. Moreover, the pictograms, signs and labels found on the device are to be observed and kept in legible condition.

The observance of all safety information enables optimal prevention of all hazards and ensures safe and trouble-free operation of the device.

2.1 General

The device is built according to the state-of-the-art technology. However, dangers may arise from this device if it is improperly used or not used according to its purpose.

Knowing the contents of the user manual is a prerequisite in order to protect yourself from danger, as well as avoid mistakes and thus operate the device safely and without interference.

To avoid danger and to assure optimum performance, no modifications or alterations may be made to the device that are not expressly approved by the manufacturer.

The device may only be operated in a technically perfect and reliable condition.

2.2 Safety instructions for use of the device

The specifications regarding operational safety are based on the regulations of the European Union valid at the time of manufacturing of the device.

If the device is used commercially, the operator is obliged, during the entire period of use, to determine the compliance of the designated occupational safety measures with the current state of regulations and take note of new regulations. Outside the European Union, work safety laws and regional regulations applicable at the place where the device is used must be observed.

Besides the industrial safety instructions in this user manual, the generally valid safety and accident prevention regulations for the application of the device, as well as environment protection regulations, must be observed and complied with.



ATTENTION!

- This device is not intended for use by individuals (including children) with reduced physical, sensory, or mental capabilities. It may also not be used by individuals who lack experience and/or knowledge unless they are supervised by a person responsible for their safety or have received instructions on how to use the device from any such authorized person.
- Children should be supervised to ensure that they do not play with the device.
- Keep this user manual in a safe place. If the device is passed on to a third party, the user manual must be handed over.
- All persons using the device must comply with the specifications in the user manual and follow the safety instructions.

- Covers with warning labels on them should only be opened by authorized technical personnel.
- The underside- and the rear of the device must not be cleaned with a water jet.
- Protective covers and safety devices must not be removed, as this poses a risk of injury.
- The control unit should only be opened by authorized technical personnel.
- Airflows in the device area caused by improperly installed ventilation (e.g., air conditioning) or drafts must be avoided to ensure the device functions properly.
- The ambient temperature should not exceed +25°C, and the relative humidity should not exceed 60%.
- The device is not suitable for operation in entrance or outdoor areas.
- The device must be protected from direct sunlight.
- Glass surfaces must be handled with care to avoid injury from glass breakage.
- Components and operating materials should only be replaced with original parts.
- Do not store flammable or explosive products in or near the device.
- The device must be properly enclosed during installation so that no contact with electric parts is possible.
- The installation environment must be stable and capable of withstanding daily loads.
- All covers that are mounted during installation must not be removable without tools.
- After cleaning, maintenance, or servicing, the device must be checked for loose connections, shear points and damage. Any defects found must be immediately repaired!
- The device must not be used for unintended purposes!
- When refilling refrigerant, only use the refrigerant specified on the nameplate (label).
- The refrigerant refill should only be carried out by authorized technical personnel.
- The amount specified on the label must be adhered to.
- The device must be installed away from heat sources in a dust-free and well-ventilated environment.
- The device must not be moved or shifted during operation. Devices must be lifted for transport or relocation (depending on the model).

2.3 Intended Use

The reliability of the device is only guaranteed if used properly in accordance with the specifications in the user manual.

Any technical interventions, assembly and maintenance are to be made by qualified service personnel.

The "**Cold Plate**" plate is for keeping dishes **cool** (not for **cooling**) of prepared dishes.



ATTENTION!

Any and all use diverting from and/or going beyond the limits of the device is forbidden and is considered to be improper.

Any claims against the manufacturer and/or its agents for damages resulting from improper use of the device are excluded.

The operator is liable for all damages resulting from improper use.

2.4 Safety Instructions for Devices with Refrigerant Isobutane R600a

The refrigerant R600a, also known as Isobutane, is a natural refrigerant used in many household cooling devices such as refrigerators and freezers. It is more environmentally friendly than traditional refrigerants and has a low greenhouse potential. R600a helps reduce the ecological footprint of cooling systems.

- The opening of the refrigeration circuit and the evacuation of the refrigerant must be carried out only in well-ventilated areas or outdoors. These activities must only be carried out by authorized, trained personnel knowledgeable in the handling of the refrigerant R600a!
- Work on the refrigeration system must only be performed by authorized, skilled personnel trained in handling flammable refrigerant Isobutane (R600a)!
- The refrigeration circuit and the cooling system of the device must not be damaged. This could result in an unintended exothermic reaction of the flammable gas-air mixture.
- Ventilation openings in the device casing (including accessories) must not be obstructed or covered. In case of a refrigerant leak, this could result in an unintended exothermic reaction of the flammable gas-air mixture!
- Ventilation openings on the front and rear of the devices must be kept clear. The minimum distances to other devices must be maintained. Air circulation must be unrestricted!
- In the event of a refrigerant leak, obstructing air circulation could result in an unintended exothermic reaction of the flammable gas-air mixture!
- According to DIN EN 378-1, refrigerant R600a is flammable and explosive (refrigerant group A3).
- The specified charge amount on the nameplate must be adhered to. Overfilling can cause damage to components of the refrigeration circuit!



NOTE! Failure to observe the given instructions may void the warranty claim!

3. TRANSPORT, PACKAGING AND STORAGE

3.1 Transport inspection

The delivery must be checked immediately upon receipt for completeness and transport damage.

In case of visible transport damage, do not accept the delivery, or only do so conditionally.

The extent of the damage on the transport has to be marked on the documents / delivery note. Initiate complaint.

A complaint regarding hidden damage has to be reported, immediately after discovery, as claims for damages can only be asserted within the effective period for complaints.

3.2 Packaging

Do not throw away the cardboard packaging of your device. It might be useful for storage purposes, when moving or if the device needs to be sent to our service centre in case of damage. The outer and inner packaging material has to be removed from the device before use.



NOTE!

If you want to dispose of the packing, consider the regulations applicable in your country. Recycle re-usable packing materials.

Please check that the device and its accessories are complete. If any part is missing, please contact our customer service center immediately.

3.3 Storage

Keep the package closed until installation, under consideration of the indicated positioning and storage markings.

Store the packages under the following conditions:

- Do not store outdoors.
- Keep dry and free of dust.
- Do not expose to aggressive media.
- Protect from direct sunlight.
- Avoid mechanical vibrations.



ATTENTION!

The device shall not be turned upside down.

4. TECHNICAL DATA

4.1 Technical Specifications

Description:	Cold Plate			
Variants:	Installation Variants: plug-in or remote cooling system (Z) or On Counter Variants (A)			
Sizes:	GN1	GN2	GN3	GN4
Amount Refrigerant Plug-in / On Counter [Gram]:	~ 40	~ 45	~ 50	~ 55
Material Surface:	patented aluminum plate with cooling coils. Optionally with stainless steel surface, glass or artificial stone (Dekton)			
Temperature Range:	-5 °C to +15 °C, continuously adjustable			
Refrigerant for remote cooling system:	R134a, R404a, R507a			
Refrigerant Plug-in / On Counter:	R600a	R600a	R600a	R600a
Electrical Cooling Capacity Plug in / On Counter [Watt]:	100	100	100	100
Electrical Cooling Capacity Remote Cooling System [Watt]:	20			
Cooling Performance [Watt]:	330			
Power Requirement:	230 V ~ 50/60 Hz			
Dimensions Plug-in [mm]:	B330xT530xH190	B660xT530xH190	B990xT530xH190	B1325xT530xH190
Dimensions Remote cooling system [mm]:	B330xT530xH140	B660xT530xH140	B990xT530xH140	B1325xT530xH140
Dimensions On Counter Metal [mm]:	B345xT545xH200	B675xT545xH200		
Dimensions On Counter Wood Line [mm]:	B440xT645xH200			
Cut-Out Dimensions Wood/stainless steel [mm]:	B340xT540	B670xT540	B1000xT540	B1335xT540
Cut-Out Dimensions Dekton/stone [mm]:	B344xT544	B674xT544	B1004xT544	B1339xT544
Condensing Temperature plug-in/On Counter [°C]:	-12,1	-12,1	-12,1	-12,1
Evenness Tolerances at Surround Temperature [mm]*:	0,5	1,0	1,5	2,0

Subject to Modifications!

4.2 Product Diagram

4.2.1 Installation Variant – plug-in (diagram size GN1)

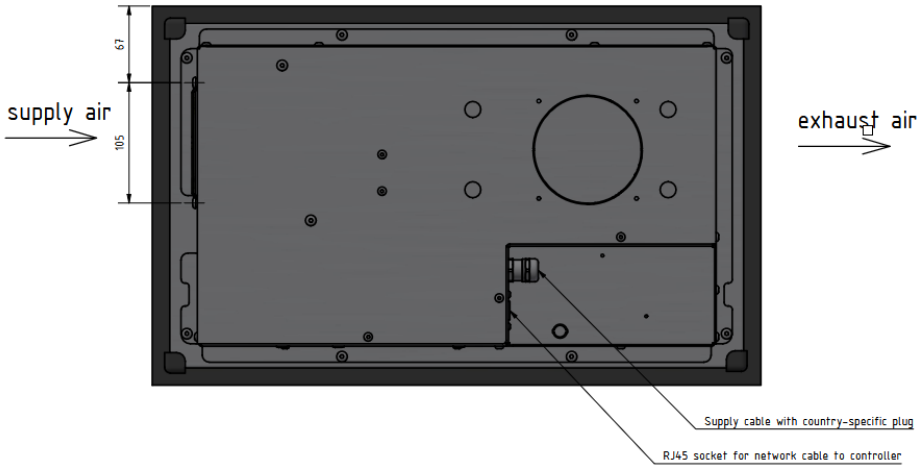

4.2.2 Installation Variant – Remote Cooling System (diagram size GN1)

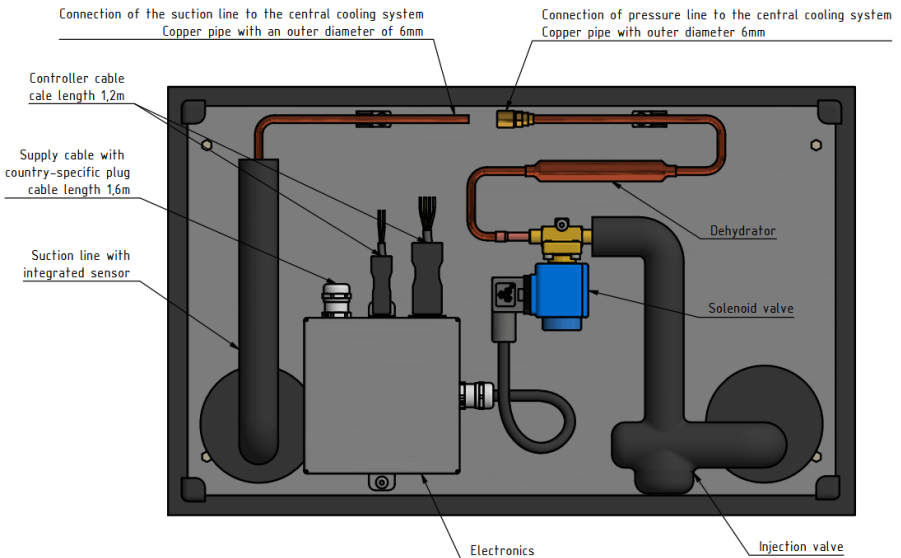

4.2.3 On Counter - (diagram size GN1)

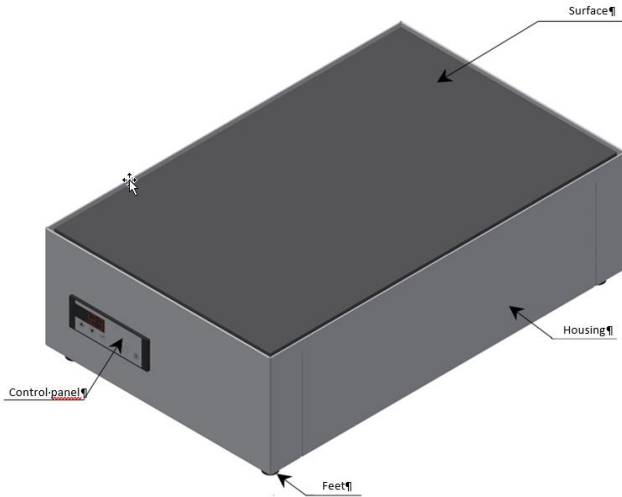

4.3 Scope of Supply

Varies between plug-in, remote cooling system and on counter.

Variant	Plug-in	Remote cooling system	On Counter
Connection cable with Schuko plug 1,6 m	•	•	•
Controller with cable length 1,2 m	•	•	•*
User manual	•	•	•
Connection plan circuit board		•	
Installation instructions	•	•	

*controller already installed

4.4 Labeling

The device is clearly labeled by the information on its nameplate. The nameplate is located on the underside of the device.



An additional nameplate is attached to the outside of the packaging at the factory.

An additional nameplate (as a copy) is included with each device at the factory to ensure the accessibility and legibility of the device's nameplate even after installation.

The attachment must be accessible and legible on the device for operators, installation personnel, or assembly personnel to ensure the device can be clearly identified.

4.5 Pictograms

Pictograms	Description
	Danger! No open flame, fire, open ignition sources, and smoking are prohibited!
	Warning! The Isobutane refrigerant R600a is flammable.
	The internal components remain dry when sprayed with water from all directions.

5. INSTALLATION AND OPERATION

5.1 Safety information



WARNING! Risk of electrocution!

The device must be installed by qualified professionals.

- Device may cause injuries due to improper installation!
- Before installation, check the data of the local power grid with the technical specifications of the unit (see nameplate).
- Connect the device only if they match! Follow the safety instructions!
- The device may only be operated when connected to a properly installed single socket with protective contact. Don't use any multiply sockets.
- A safety switch is mandatory when installing a unit.
- Do not pull the plug from the socket by the cable.
- The power cord must not come into contact with hot parts.



WARNING! Hot parts!

During operation, some parts of the device become very hot. To avoid burns, do not touch hot parts!

- Do not use this device if it is not working properly, is damaged or has been dropped.
- Do not use any accessories and spare parts which are not recommended by the manufacturer. These could pose a hazard to the user or cause damage to the device and cause personal injury, and also void the warranty.
- Do not lay the cable over carpets or other heat insulation. Do not cover the cable. Keep the cable away from work areas and do not immerse in water.
- Do not move the device during operation and do not tip it over.
- The Cold Plates must not be used as a storage area.
- Make sure that the cable does not come into contact with heat sources or sharp edges. Do not hang the cable off the table or counter.

5.2 Installation and Electric Connection

5.2.1 Installation (only valid for installation variants)

- Put your device on a level and safe surface which stands the weight of the device.
- Prepare the cut-out of the table according to our installation drawings and check the cut-out. A silicone gap of 5 mm for wood and stainless-steel buffets all around the unit, and a gap of 7 mm for stone and Dekton is mandatory. The maximum corner radius shall not be wider than the silicon gap.
- For Dekton (artificial stone) and stone plates please refer to the stone manufacturer's references.
- Now fix our mounting brackets which are available as accessories.
- Make sure the surface is free from dust and grease.
- Put your plate into the cut-out and adjust the accurate height with the adjusting screws. Please make sure that the plate fits exactly.
- Connect the controller and both cables to the circuit board according to the connection plan.
- Locate the plate in the middle of the cut-out.
- Grout the plate with the original Höller silicone which is available in the accessories and remove the excess silicone.
- After a drying time of 24 hrs, you can connect the plate to the power supply and start to operate.



NOTE regarding the Installation

- The device has to be installed in vertical position.
- The Cold Plate has to left in vertical position at least 15 minutes before operation.
- The installation variants of the Cold Plates can be built-in flush-mounted or sunk in every top plate (wood, granite, corean or stainless steel; see installation drawing). Please use our mounting brackets which are available as accessories for installation.
- The supply and exhaust air must be ensured for all the plug-in units.
The ambient temperature of 30°C mustn't exceed in operation (heat accumulation) because the cooling performance decreases and the device might get damaged. Please note that warm air rises. Please use parts of the wide range of built-in accessories like fans or tubes in adverse built-in situations. Referring to this, the qualified professional can give you some advices.



ATTENTION!

The device must be installed by qualified professional.

Further details can be found under section 2.4!

5.2.2 Electrical connections

- The socket circuit must be secured according to the performance details.
- Connect the controller to the circuit board.
- Plug the Schuko plug into the socket.







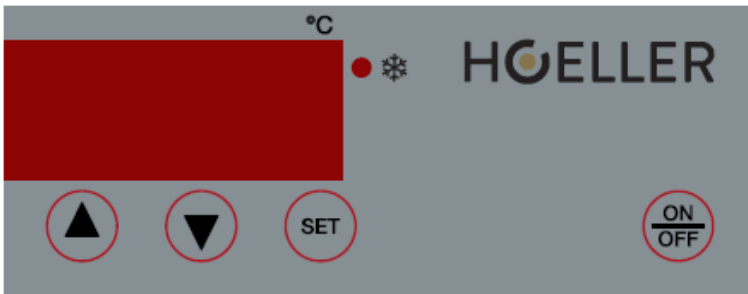

5.3 Operation

- Clean the device prior to use as described in chapter 6.2 "Cleaning".
- Press the  button to switch on the device.
- Do not place food directly on the surface. All foods should always be placed in appropriate containers on the surface of the Cold Plate. Use only suitable tableware. **Do not use plastic tableware.**
- Do not use pots or pans with a bottom which has ridged edges or is unevenly enameled. This can cause permanent scratches.

5.3.1 Control panel

The Cold Plate can be set and operated via the touch control panel mounted on the front. The four buttons are used for adjusting settings, quick choice between preset values, as well as parameterization. Only press the buttons using a finger or a Touchpen.



ON/OFF button 	With this button the device is turned on or off. When turning it on, the last selected mode starts.
Button  	These buttons are for adjusting the temperature.
Button 	By pressing the  button, the adjusted temperature will be shown in the display. To change the temperature press  and either  or  , to adjust the temperature accordingly.
Display Cool Mode: 	The unit is in cooling mode.

Digital display:	Shows the actual and by pressing the  button the target temperature.
-------------------------	--



ATTENTION!

A change in the preset parameters should only be carried out by customer service.

The maximum working temperature for the controller is +55° C, Temperatures above this limit value inside the cabinet can lead to failures and permanent damages of the controller.

6. CLEANING AND MAINTENANCE

6.1 Safety instructions for cleaning

- Before cleaning and before repairing, disconnect the device from the outlet (pull the plug!) and allow it cool.
- Do not use caustic cleaning agents and make sure that no water seeps into the device.
- To protect yourself from electric shock, do not immerse the device, cable or socket in water or other liquids.



ATTENTION!

The device is not suited for direct washing with a water jet. Therefore, do not use a pressure water jet to clean the device!

6.2 Cleaning

Clean the device regularly with a neutral cleaning agent!

- Before cleaning the device, switch it off with the  button and disconnect from the electrical outlet (pull the plug!).
- Leave the device to cool.
- Afterwards clean the surface with a damp cloth.
- Do not use abrasives that could scratch the surface of the Cold Plates.
- **Never** scrape the painted surface of the Cold Plate with a knife, fork, metal scrapers or other sharp objects, nor use abrasives, steel wool or similar.
- Do not clean the joint between the frame and Cold Plate with sharp objects.
- After cleaning, use a soft cloth to dry and polish the surface.

6.3 Safety instructions for maintenance

- Check the main cable for damage from time to time. Do not use the device if the cable is damaged. If the cable is damaged, it must be replaced by customer service or a qualified electrician to avoid risks.
- In case of damage or malfunction, please contact your dealer or our customer service department. Keep in mind the information on troubleshooting in section 7.
- Maintenance and repair work may only be performed by qualified professionals using original spare parts and accessories. **Never try to carry out repairs to the device yourself.**

6.4 Maintenance

- Check in regular periods if the grouting of the plates has cracks and adjust it accordingly. Due to bad grouting, water can enter and lead to discolorations, breakage and loosening of the surface.
- Check in regular periods if the evaporator is dirty and let it clean by a qualified professional if necessary.
- Check the glass for damages before every use, before resuming operations to avoid injuries.
- Further maintenance details can be found under section 2.4!

7. POSSIBLE MALFUNCTIONS

Problem	Cause	Remedy
No function	<ul style="list-style-type: none"> • Power plug not plugged in properly • Fuse of the power supply has tripped. • Controller not plugged in properly 	<ul style="list-style-type: none"> • Pull out the plug and insert it correctly • Check fuse, test unit on a different elec. socket. • Note connection plan
No display function	<ul style="list-style-type: none"> • Controller cable disconnected • Controller cable not connected correctly 	<ul style="list-style-type: none"> • Check the connection • Note connection plan
No cooling	<ul style="list-style-type: none"> • Compressor turned off • Temperature controller faulty • Temperature above 40 °C 	<ul style="list-style-type: none"> • Check supply and exhaust air • Contact the seller • Allow device to cool down to below 40 °C
Bad cooling	<ul style="list-style-type: none"> • Evaporator dirty • Fan dirty • Overheating on installation site 	<ul style="list-style-type: none"> • Cleaning by service engineer • Cleaning by service engineer • Check supply and exhaust air
Display shows “FIH” or “Fill”	<ul style="list-style-type: none"> • Broken sensor 	<ul style="list-style-type: none"> • Contact the seller
Temperature varies for more than 20° C	<ul style="list-style-type: none"> • Broken sensor 	<ul style="list-style-type: none"> • Contact the seller • Don't further use the device to prevent subsequent damage

The problems listed above are for guidance and must be seen as examples. Should these or similar problems occur, immediately turn off the device and discontinue use. Contact a qualified specialist or the manufacturer immediately.

Noise during operation (only for compact system)

To keep the selected temperature constant when cooling, from time to time, the Cold Plate switches the compressor of the cooling unit on. The sounds which occur are related to functionality. They will reduce automatically as soon as the unit has reached operating temperature. The humming noise comes from the compressor.

8. DISPOSAL

Old equipment

Your old device must be disposed of at the end of its service life in accordance with local regulations. It is advisable to contact a specialized waste management company, or to contact the local disposal service in your community.



WARNING!

To avoid misuse and the associated dangers, make sure the old device is unfit for use before disposal. For this purpose, disconnect the device from the power supply and remove the power cord from the unit.



NOTE!



For the disposal of the device, pay attention to the regulations which apply in your country and region.

9. CONFORMANCE DECLARATION

Hoeller Manufacturing GmbH
Peter-Mitterhofer-Straße 4
3300 Amstetten
Austria

HOELLER
MANUFACTURING

DECLARATION OF CONFORMITY

With this declaration,

Hoeller Manufacturing GmbH
Peter-Mitterhofer-Straße 4
A-3300 Amstetten

hereby declares, at its sole responsibility, that the products described below

Cold Plate

In-counter models

- **Plug-in ready**
- **Remote cooling system**

On-counter models

Year of Manufacture: starting from 2024

to which this declaration is applicable, has been manufactured in compliance with the standards, regulations and generally accepted rules of technology listed below.

- | | |
|---|------------------------|
| • Low Voltage Directive | 2014/35/EU |
| • Electromagnetic Compatibility | 2014/30/EU |
| • Restriction of the use of certain hazardous substances in electrical appliances | 2011/65/EU |
| • Safety of Electrical Devices | |
| - Part 1: General Requirements | EN 60335- 1:2012-10 |
| - Part 2-89: Commercial refrigerators | EN 60335- 2-89:2019-04 |
| • Safety of Machinery | EN ISO 12100 |
| • Refrigeration units | DIN EN 378-2 |

Hoeller Manufacturing GmbH holds documentation ready for inspection as proof of compliance with the safety objectives and the essential safety requirements.

Amstetten 01.01.2024

HOELLER
MANUFACTURING
Hoeller Manufacturing GmbH
Peter-Mitterhofer-Straße 4
3300 Amstetten
AUSTRIA
T +43 7472 233 29

Hoeller Manufacturing GmbH
Stamp & Signature

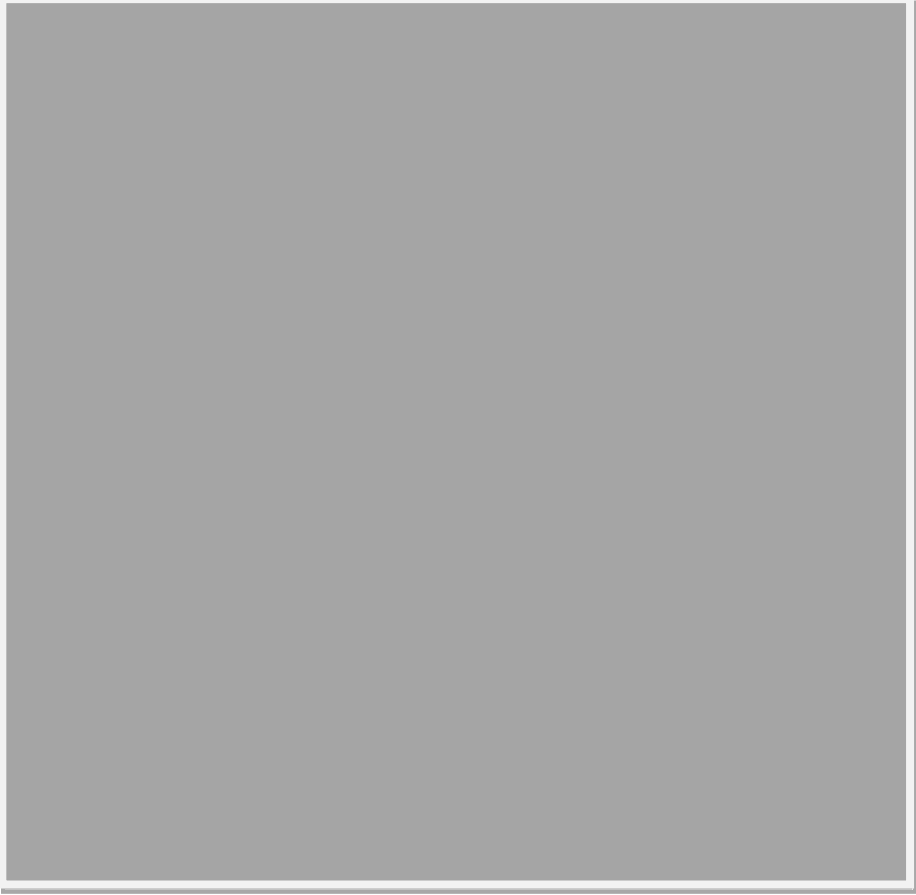

Hoeller Manufacturing GmbH

Peter-Mitterhofer-Straße 4
3300 Amstetten

Tel.: +43 7472 233 29

office@hoeller-solutions.com

HOELLER
MANUFACTURING